



# Circuit Design Training Manual: Low Noise Amplifier Part I



ANSYS, Inc.  
Southpointe  
2600 Ansys Drive  
Canonsburg, PA 15317  
[ansysinfo@ansys.com](mailto:ansysinfo@ansys.com)  
<https://www.ansys.com>  
(T) 724-746-3304  
(F) 724-514-9494

Release 2024 R2  
July 2024

ANSYS, Inc. and  
ANSYS Europe,  
Ltd. are UL  
registered ISO  
9001:2015  
companies.

## Copyright and Trademark Information

© 1986-2024 ANSYS, Inc. Unauthorized use, distribution or duplication is prohibited.

ANSYS, Ansys Workbench, AUTODYN, CFX, FLUENT and any and all ANSYS, Inc. brand, product, service and feature names, logos and slogans are registered trademarks or trademarks of ANSYS, Inc. or its subsidiaries located in the United States or other countries. ICEM CFD is a trademark used by ANSYS, Inc. under license. All other brand, product, service and feature names or trademarks are the property of their respective owners. FLEXlm and FLEXnet are trademarks of Flexera Software LLC.

## Disclaimer Notice

THIS ANSYS SOFTWARE PRODUCT AND PROGRAM DOCUMENTATION INCLUDE TRADE SECRETS AND ARE CONFIDENTIAL AND PROPRIETARY PRODUCTS OF ANSYS, INC., ITS SUBSIDIARIES, OR LICENSORS. The software products and documentation are furnished by ANSYS, Inc., its subsidiaries, or affiliates under a software license agreement that contains provisions concerning non-disclosure, copying, length and nature of use, compliance with exporting laws, warranties, disclaimers, limitations of liability, and remedies, and other provisions. The software products and documentation may be used, disclosed, transferred, or copied only in accordance with the terms and conditions of that software license agreement.

ANSYS, Inc. and ANSYS Europe, Ltd. are UL registered ISO 9001: 2015 companies.

## U.S. Government Rights

For U.S. Government users, except as specifically granted by the ANSYS, Inc. software license agreement, the use, duplication, or disclosure by the United States Government is subject to restrictions stated in the ANSYS, Inc. software license agreement and FAR 12.212 (for non-DOD licenses).

## Third-Party Software

See the legal information in the product help files for the complete Legal Notice for Ansys proprietary software and third-party software. If the Legal Notice is inaccessible, please contact ANSYS, Inc.

## Conventions Used in this Guide

Please take a moment to review how instructions and other useful information are presented in this documentation.

- Procedures are presented as numbered lists. A single bullet indicates that the procedure has only one step.
- Bold type is used in the following circumstances:
  - Keyboard entries that should be typed in their entirety exactly as shown. For example, "**copy file1**" means you must type the word **copy**, then type a space, then type **file1**.
  - On-screen prompts and messages, names of options and text fields, and menu commands. Menu commands are often separated by greater than signs (>). For example, "click **HFSS > Excitations > Assign > Wave Port.**"
  - Labeled keys on the computer keyboard. For example, "Press **Enter**" means to press the key labeled **Enter**.
- Italic type is used in the following circumstances:
  - Emphasis.
  - The titles of publications.
  - Keyboard entries when a name or a variable must be typed in place of the words in italics. For example, "**copyfilename**" means you must type the word **copy**, then type a space, then type the name of the file.
- The plus sign (+) is used between keyboard keys to indicate that you should press the keys at the same time. For example, "Press **Shift+F1**" means to press the **Shift** key and, while holding it down, press the **F1** key also. You should always depress the modifier key or keys first (e.g., **Shift**, **Ctrl**, **Alt**, or **Ctrl+Shift**), continue to hold it/them down, then press the last key in the instruction.

**Accessing Commands:** *Ribbons*, *menu bars*, and *shortcut menus* are three methods that can be used to see what commands are available in the application.

- The *Ribbon* occupies the rectangular area at the top of the application window and contains multiple tabs. Each tab has relevant commands that are organized, grouped, and labeled. An example of a typical user interaction is as follows:

"Click **Schematic > Ground**"

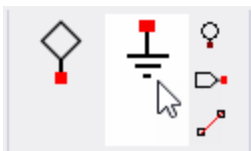

This instruction means that you should click the **Ground** command on the **Schematic** ribbon tab. An image of the command icon, or a partial view of the ribbon, is often included with the instruction.

- The *menu bar* (located above the ribbon) is a group of the main commands of an application arranged by category such File, Edit, View, Project, etc. An example of a typical user interaction is as follows:

"From the **File** menu, select the **Open Examples** command" means click the **File** menu, then click **Open Examples** to open an explorer window to the **Examples** folder.

- Another alternative is to use the *shortcut menu* that appears when you right-click. An example of a typical user interaction is as follows:

"Right-click and select **Assign Excitation > Wave Port**" means select an object, right-click, and click an option on the shortcut menu that appears.

### Getting Help: Ansys Technical Support

For information about Ansys Technical Support, go to the Ansys corporate Support website, <http://www.ansys.com/Support>. You can also contact your Ansys account manager in order to obtain this information.

All Ansys software files are ASCII text and can be sent conveniently by e-mail. When reporting difficulties, it is extremely helpful to include very specific information about what steps are taken or what stages the simulation reached, including software files as applicable. This allows more rapid and effective debugging.

### Help Menu

To access help on the Help menu, select **Help**. Then choose one of the following:

- **[product name] Help** - opens the contents of the help. This help includes the help for the product and its *Getting Started Guides*.
- **[product name] Scripting Help** - opens the contents of the *Scripting Guide*.
- **[product name] Getting Started Guides** - opens a topic that contains links to Getting Started Guides in the help system.

### Context-Sensitive Help

To access help on the user interface, press **F1** to open the appropriate help for the active product (design type).

You can press **F1** while the cursor is pointing at a menu command or while a particular window tab is open. In this case, the help page associated with the command or open window is displayed automatically.

about

# Table of Contents

<b>Table of Contents</b> .....	<b>Contents-1</b>
<b>1 - Low Noise Amplifier Design</b> .....	<b>1-1</b>
Prerequisite .....	1-1
Ansys Electronics Desktop .....	1-1
Enable Legacy View .....	1-3
Smith Tool .....	1-4
Set up Low Noise Amplifier Schematic .....	1-5
Creating Smith Chart Reports .....	1-7
Using the Smith Tool Utility .....	1-9
Stabilize Transistor .....	1-11
Adding Emitter Degeneration Inductor .....	1-12
Set Tuning Parameter .....	1-16
Tune Inductor .....	1-18
Matching Circuit .....	1-21
Add Constant Gain/Noise Circles .....	1-22
Smith Tool - Drawing Aids and Matching Tab .....	1-24
Input Matching Circuit .....	1-26
Smith Tool - Source/Load Mapping .....	1-28
SmithTool - Complex Conjugation .....	1-29
Output Matching Circuit .....	1-30
Building the Amplifier .....	1-31
Verifying Amplifier Performance .....	1-33



# 1 - Low Noise Amplifier Design

This document shows how to use **Circuit Design** in the **Ansys Electronics Desktop** to design a small signal 900 MHz low noise amplifier using an S-parameter model of NEC BJT NE68133, including noise parameters. The document also shows how to synthesize matching networks using the built-in Smith Tool. Tuned circuits are connected to the input and output to provide matching, essential to finalizing the design of the low noise amplifier.

## Prerequisite

To perform the training exercise, you need the relevant designs and the corresponding footprints available at the following location: Examples>Circuit>Low Noise Amplifier.

## Ansys Electronics Desktop

The **Electronics Desktop** provides a comprehensive environment for designing and simulating various electronic components and devices. The following figure shows the Ansys Electronics Desktop with **Circuit Design** included.

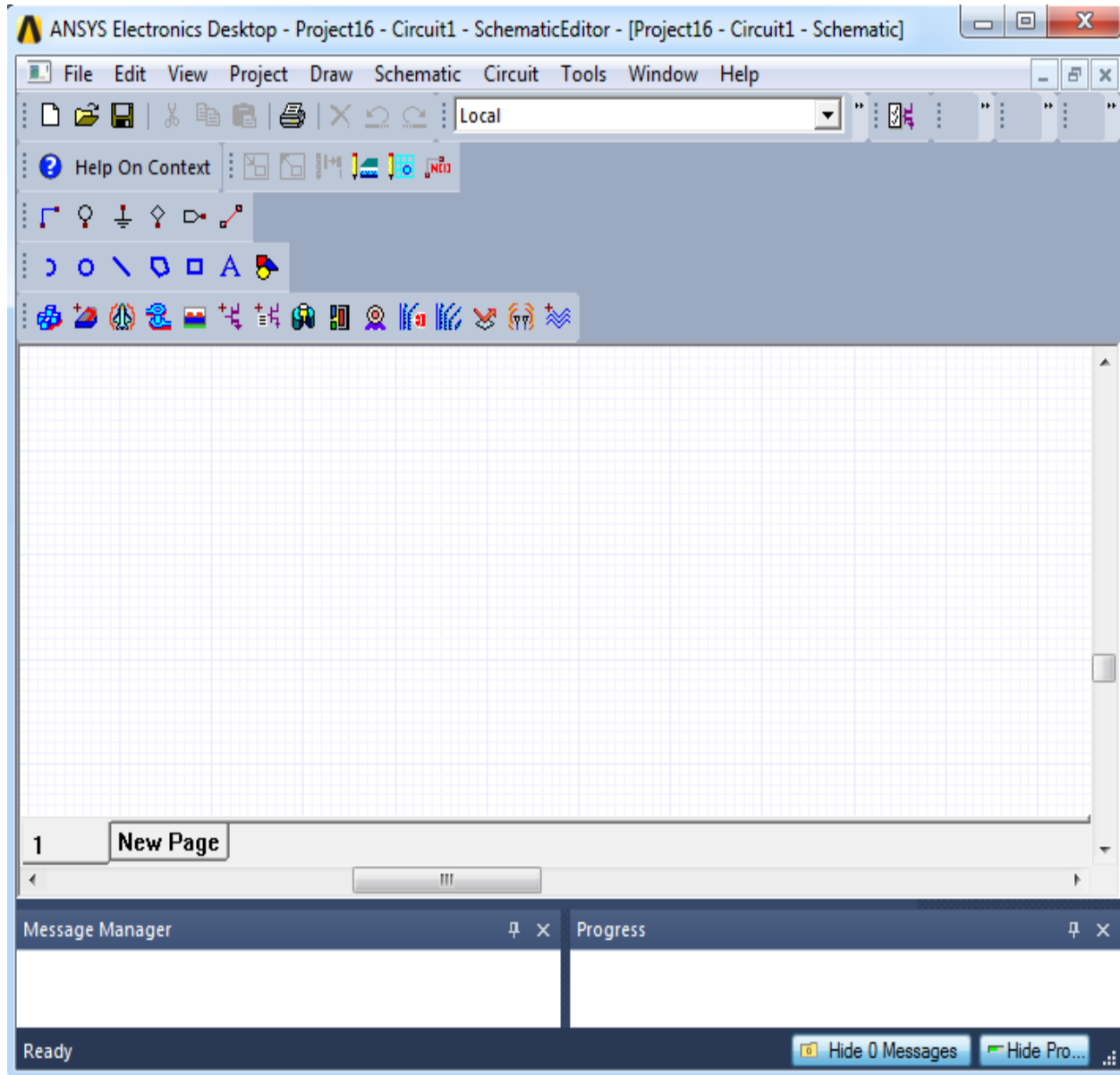

**Electronics Desktop** supports many design types. They appear as icons on the toolbar and under the **Project** menu. The relevant design type for simulating Low Noise Amplifier using an s-parameter model of NEC NE68133 BJT, is **Circuit Design**, which is illustrated in the following figure.



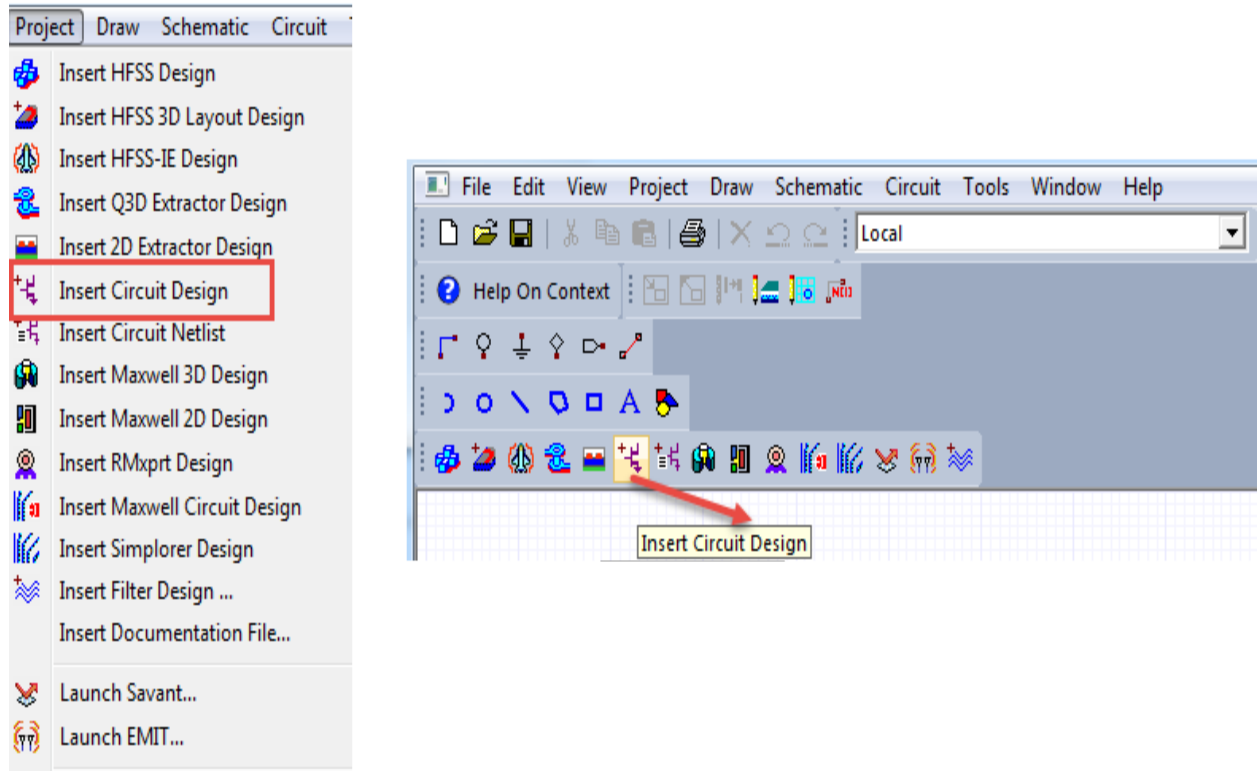

Figure 1-1 Insert Circuit Design

## Enable Legacy View

To view orientations consistent with the instructions and images in the guide, enable legacy view navigation.

1. Go to **Tools > Options > General Options**.
2. From the **Options** window, expand **General** and select **User Interface**.

### 3. Check **Enable Legacy View Navigation**

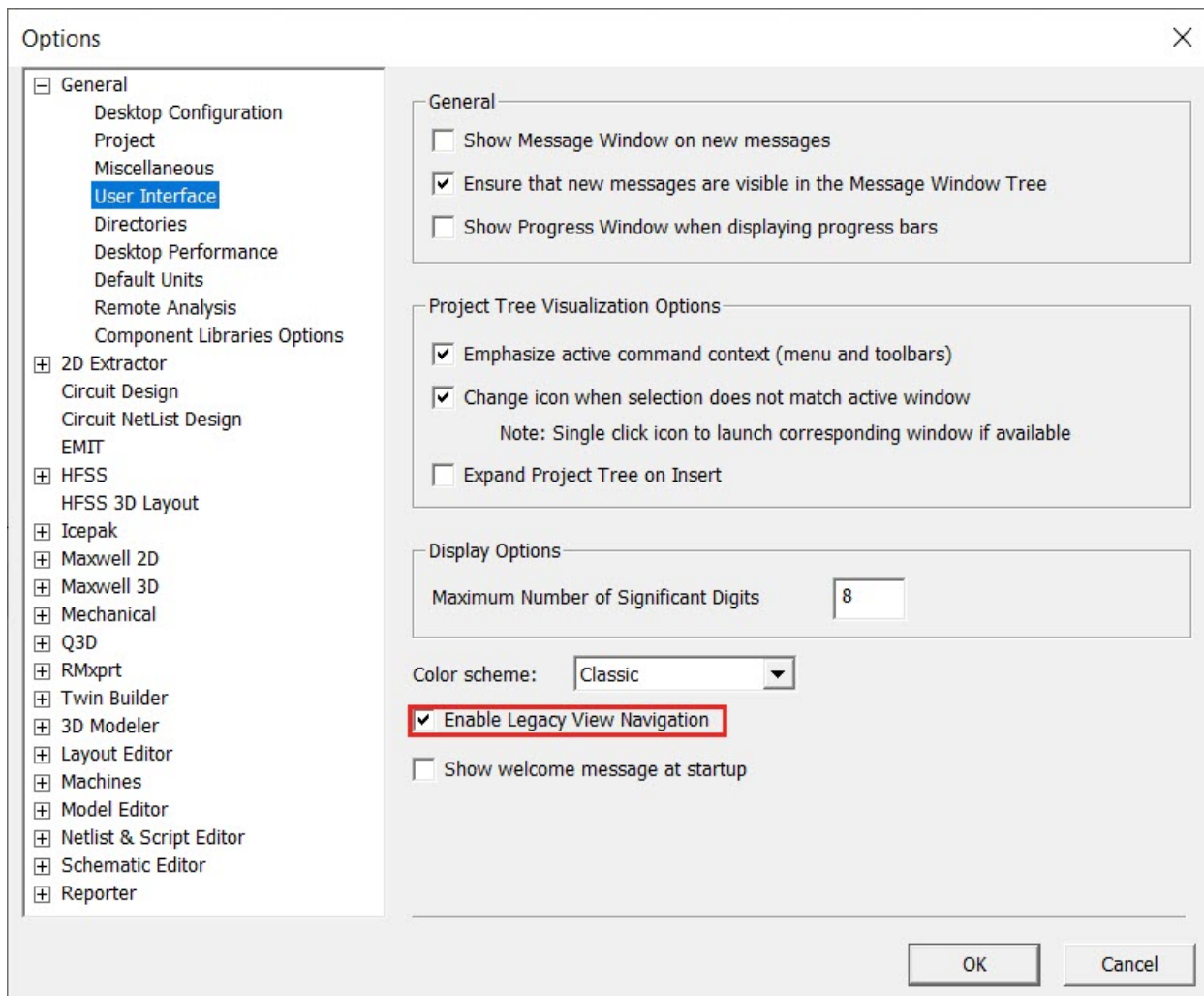

## Smith Tool

Ansys Electronics Desktop provides the interactive Smith chart utility for designing amplifiers, oscillators, and matching networks using linear analyses techniques. The Smith chart includes the following capabilities:

- Arbitrary grids for impedance, admittance, Q, VSWR, etc.
- Constant available gain and power gain circles.
- Constant noise circles.
- Stability circles.
- Circles of constant reflection for oscillator design.

- Bilateral mapping between source and load planes with gain mismatch circles.
- Ladder matching circuits using discrete and distributed elements.

## Set up Low Noise Amplifier Schematic

Set up the Low Noise Amplifier schematic in the Ansys Electronics Desktop as follows:

1. Go to **File > Open Examples > Circuit > Low Noise Amplifier**.
2. Select *LNA\_SmithTool.aedt* and save the file in a location other than the **Examples** folder. The Low Noise Amplifier schematic of the inserted design has the circuit shown in the following figure. The transistor in the schematic is an s-parameter file, including noise data at bias condition of  $V_{cc} = 2.5V$  and  $I_c = 3mA$  between 0.5 to 2 GHz.

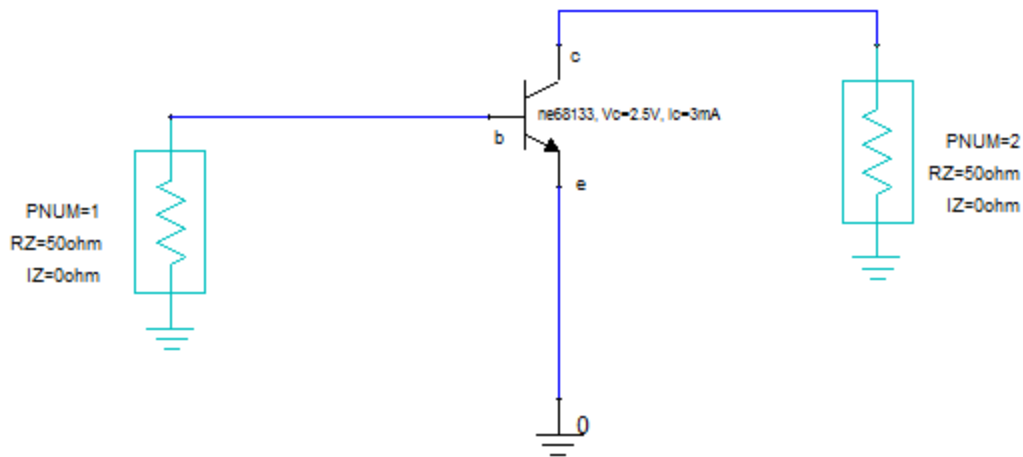

3. Double-click **Analysis** on the **Project Manager** window to check the settings in the Linear Network Analysis window.

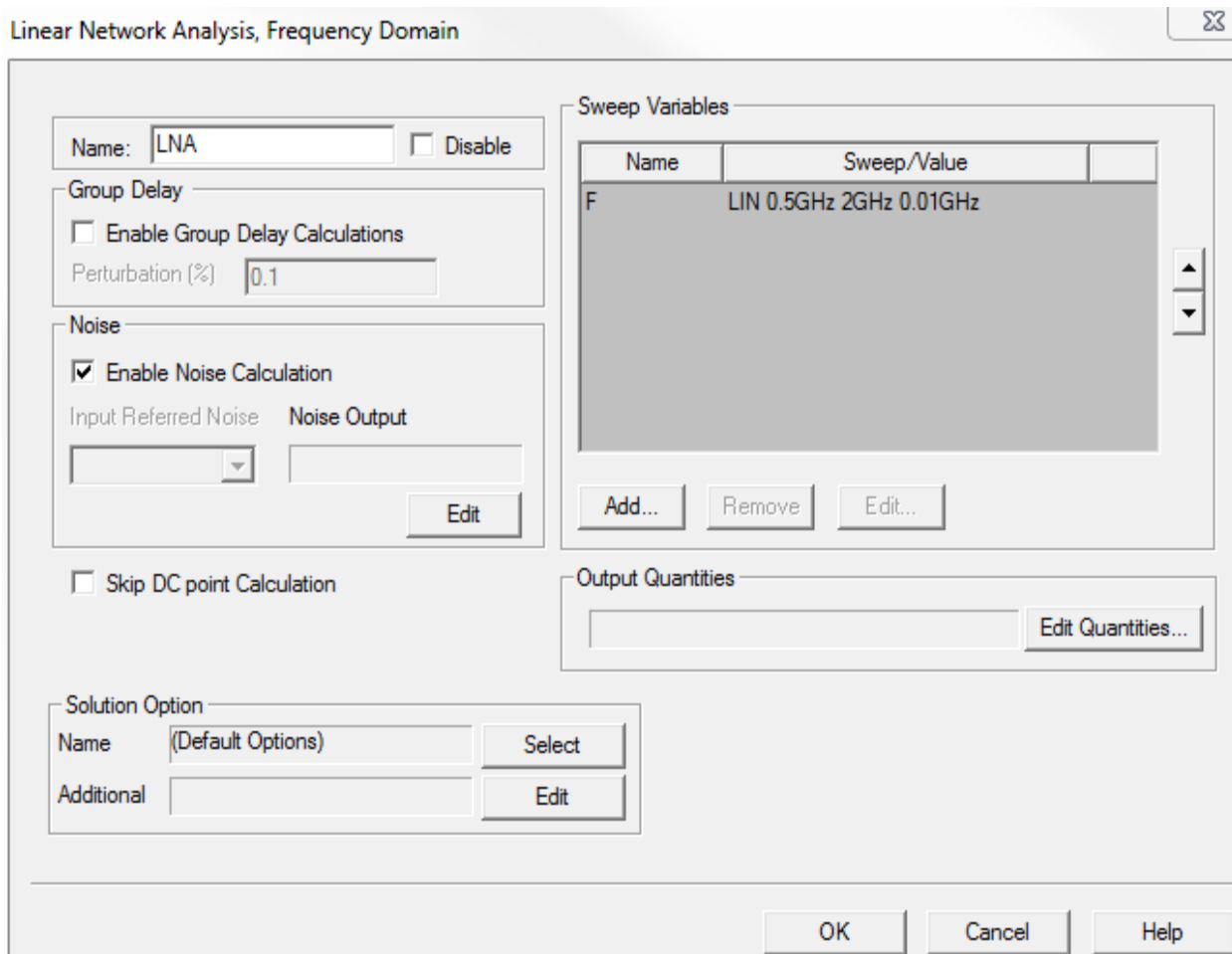

- From the **Project Manager** window, expand **Project Tree** > [active design folder] > **Analysis**. Then right-click **LNA** and select **Analyze**.

**Note:** You may see a warning about passivity violation in the Message Manager window. Since S-parameters are for an active device, ignore this warning

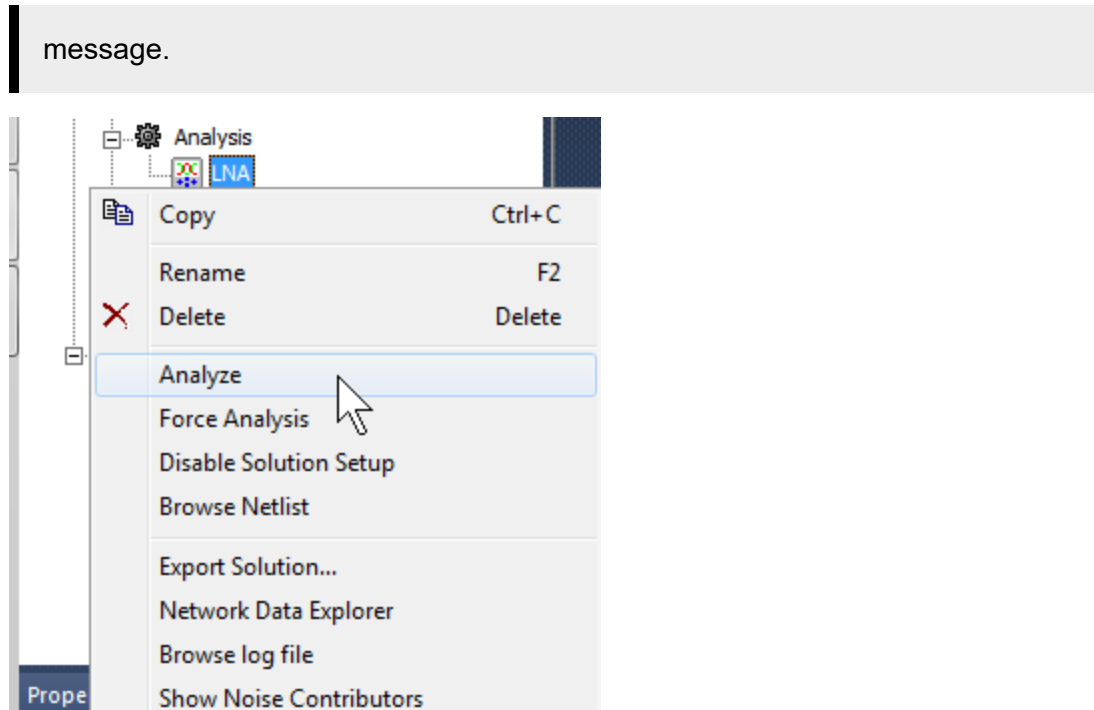

## Creating Smith Chart Reports

The example comes with the Smith Chart. If you want to generate your own report, follow these steps:

1. From the **Project Manager** window, expand the **Project Tree** and [active design folder]. Then right-click **Results** and select **Create Standard Report > Smith Chart**.

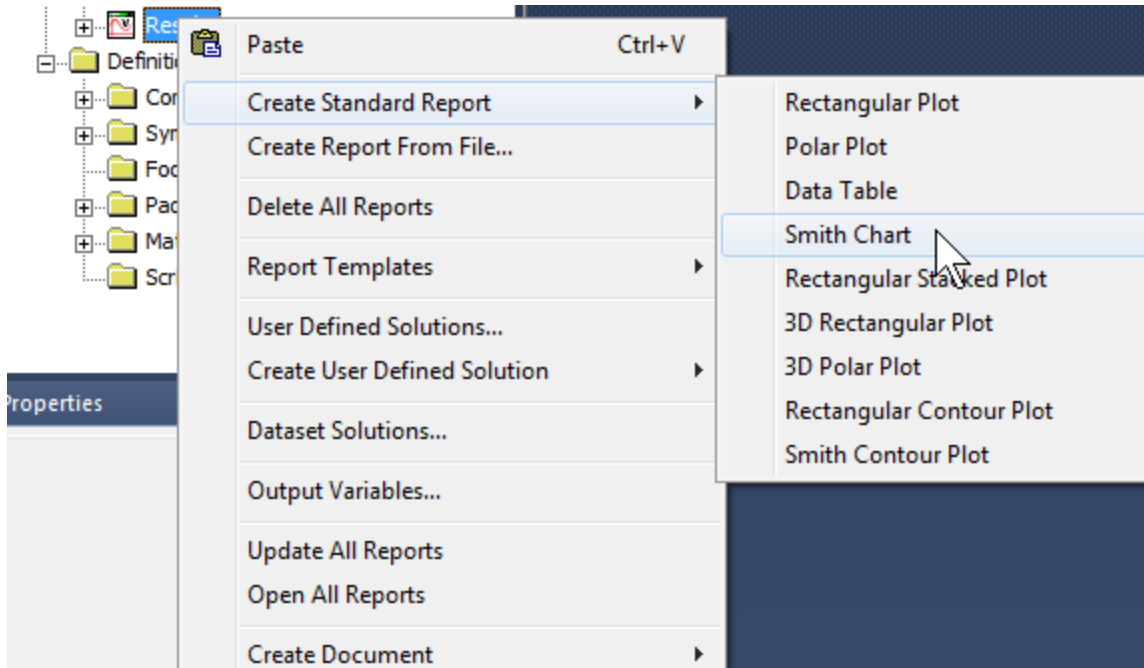

2. From the **Report** window select the following options:

- **Category:** S parameter
- **Quantity:** S(Port1, Port1)
- **Function:** <none>

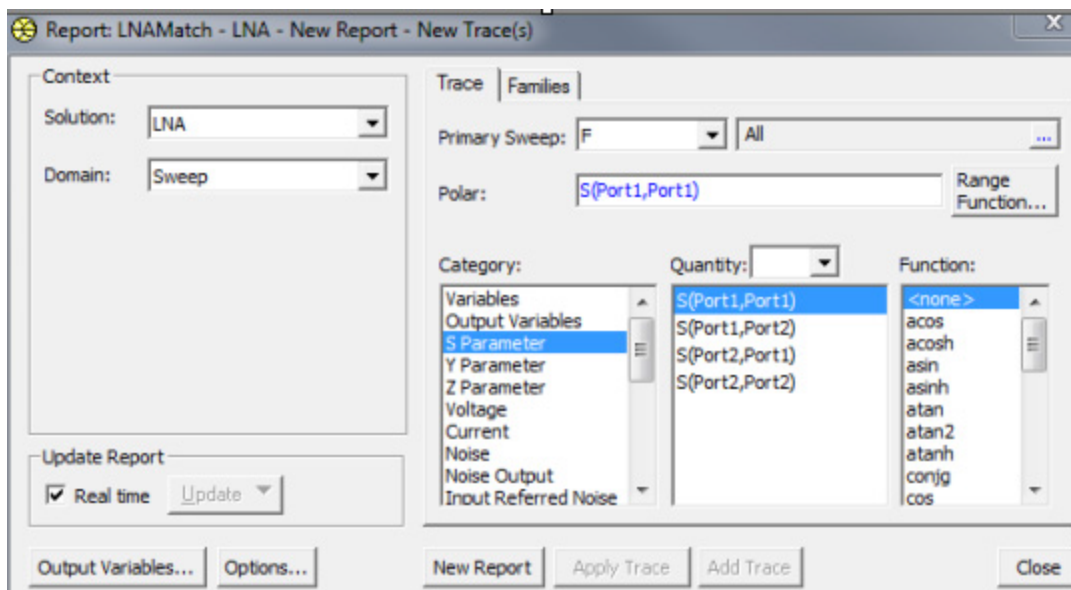

3. Click **New Report** > **Close**.

- Click **S Parameter Chart 1** in the Project Tree and rename to **Smith Chart 1**. (See the following Smith Chart.

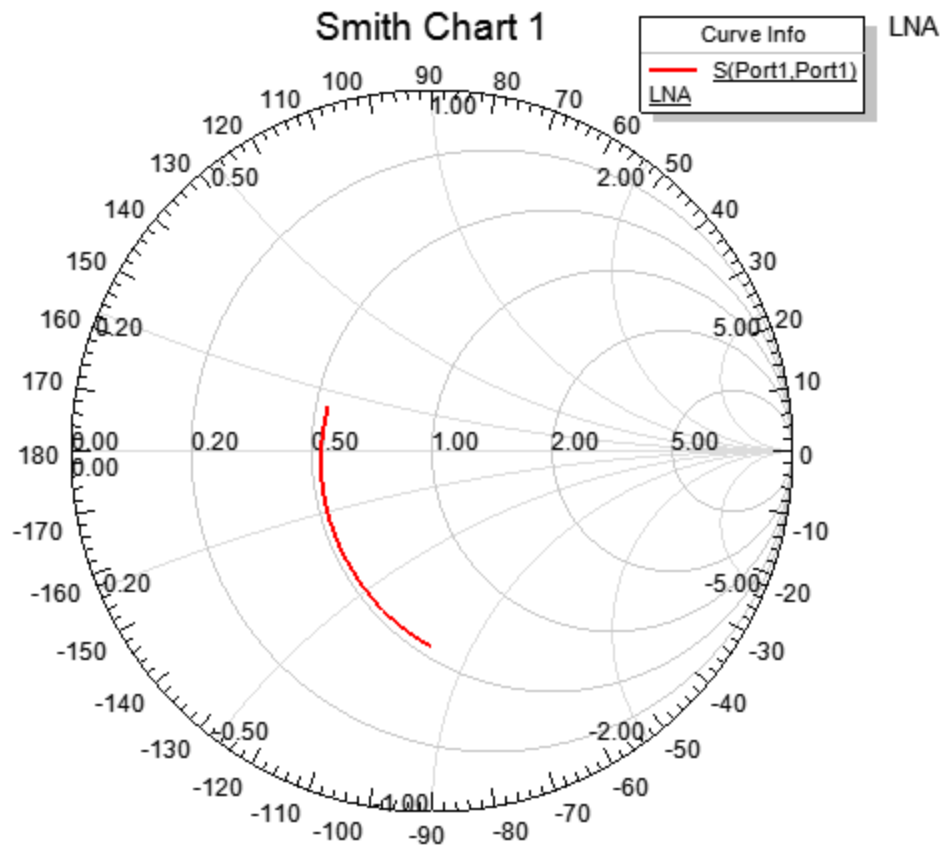

## Using the Smith Tool Utility

To access the Smith Tool utility, perform the following steps:

- Double-click Smith Chart 1 under **Results** to make the plot active.

This action updates the menu bar with the **Report2D** item.

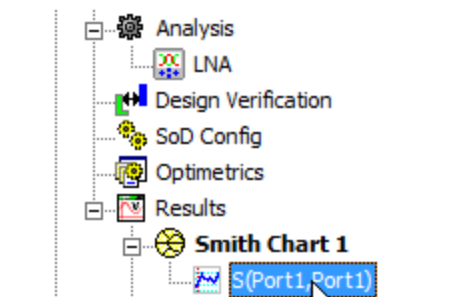

Selecting plot under Smith Chart

- From the menu bar, go to **Report2D > Smith Tool** to open the **Smith Tool** window.

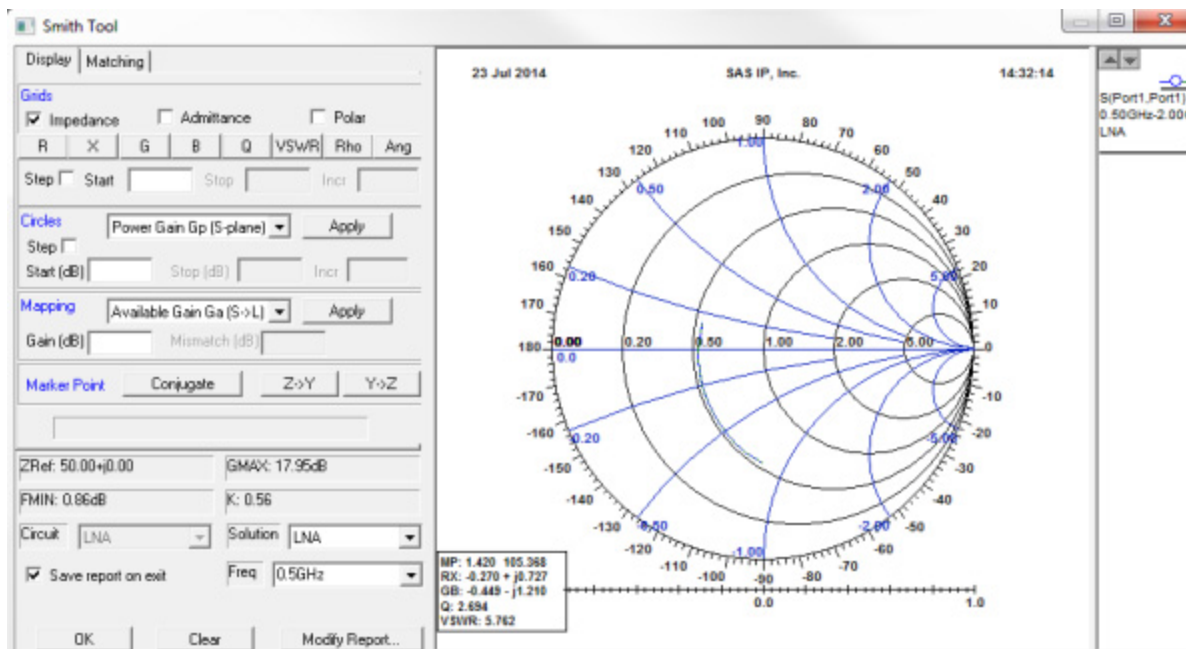

**Note:** Double-click inside the Smith Chart circle to open the **Contrast Properties** window and select the appropriate color. Change other properties as needed.





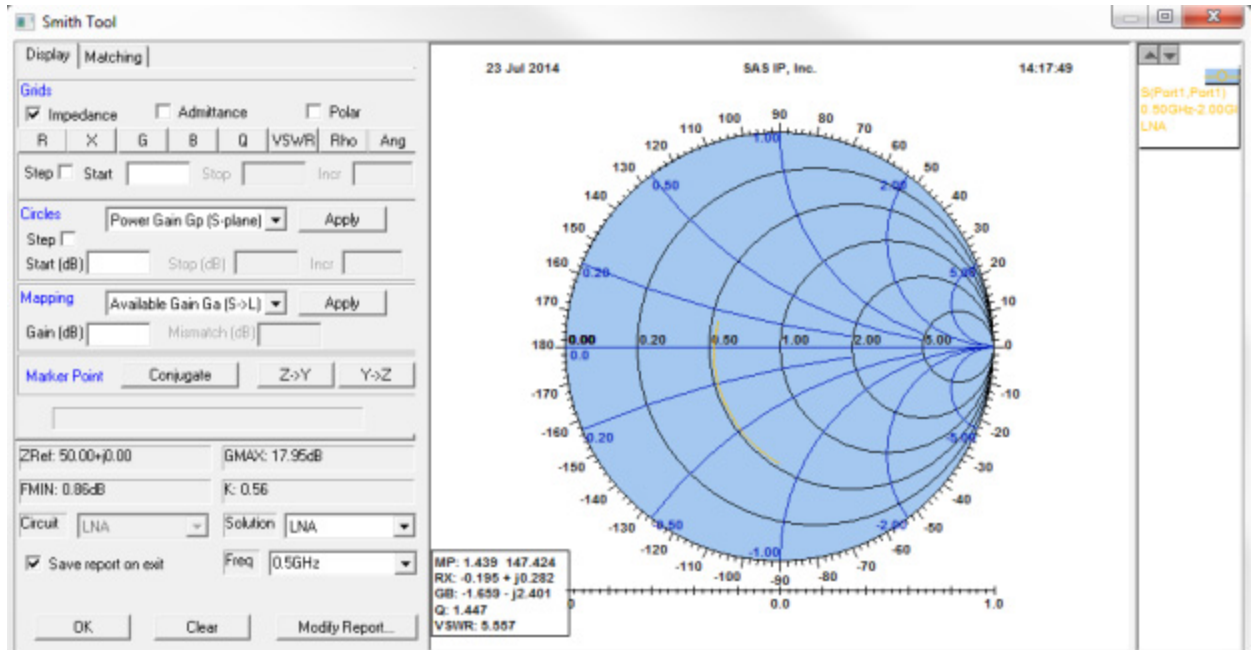

The Smith Tool Utility contains several areas as follows:

- In the Grids area, draw constant R, X, G, B, Q, VSWR, and Rho circles on the plot.
- In the Circles area, draw Gain, Noise, and Stability circles.
- In the Mapping area, transform the responses on the source plane to the load plane and vice-versa.
- At the top of the window, there are tabs to switch between the Display portion of the window and the Matching portion.
- At the bottom of the window is information that is calculated on the device S Parameters:
  - Maximum Stable Gain
  - Minimum NF
  - Stability factor

## Stabilize Transistor

The following settings are used to stabilize the transistor:

- Freq = 0.9 GHz
- Select **Stability K (S-plane)** on the **Circles** drop-down menu and click **Apply**.
- Select **Stability K (L-plane)** on the **Circles** drop-down menu and click **Apply**.
- Select the check box **Save report on exit**.

Click **OK**.

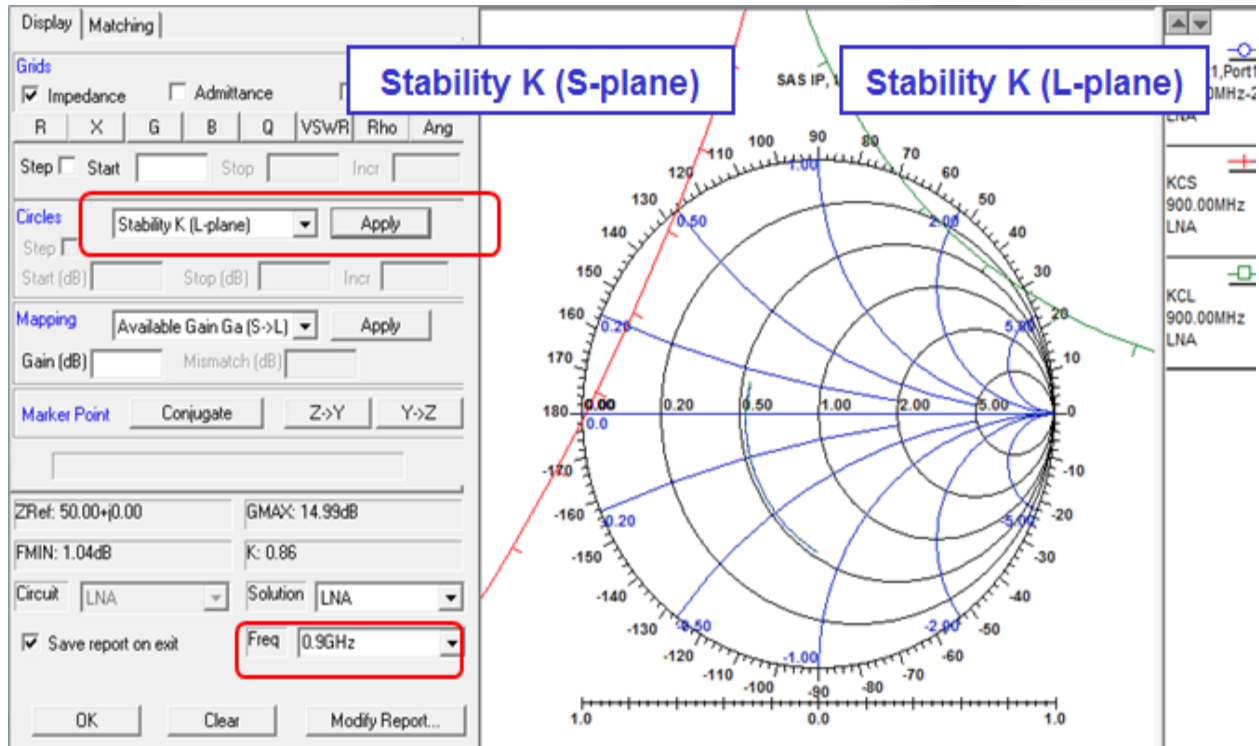
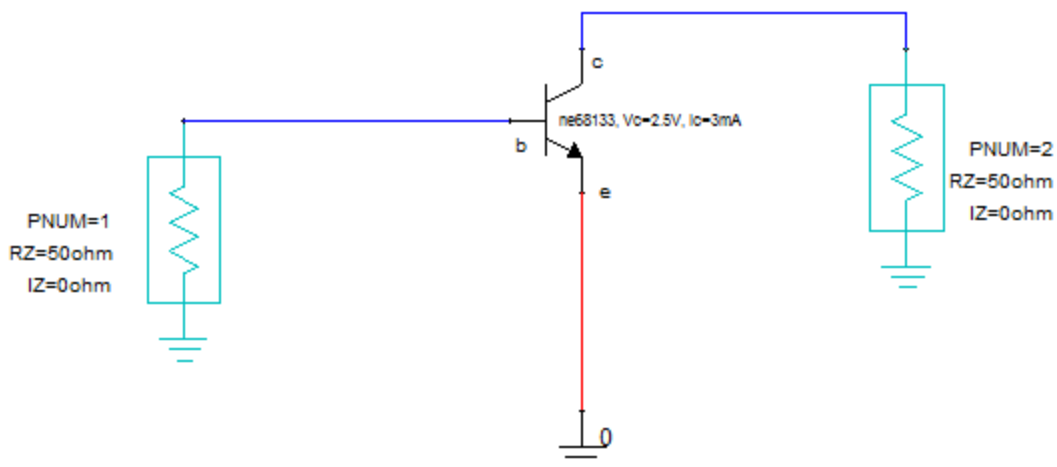

Figure 1-2 Red curve is Stability K (S-plane) and green is Stability K (L-plane)

## Adding Emitter Degeneration Inductor

Complete the following steps to add an inductor between the emitter and Gnd.

1. Right-click the link between the emitter and Gnd, and select **Delete**.



- From the **Components** library, drag and drop the first inductor on the list **IND\_:Inductor** into the schematic and press **Esc**.

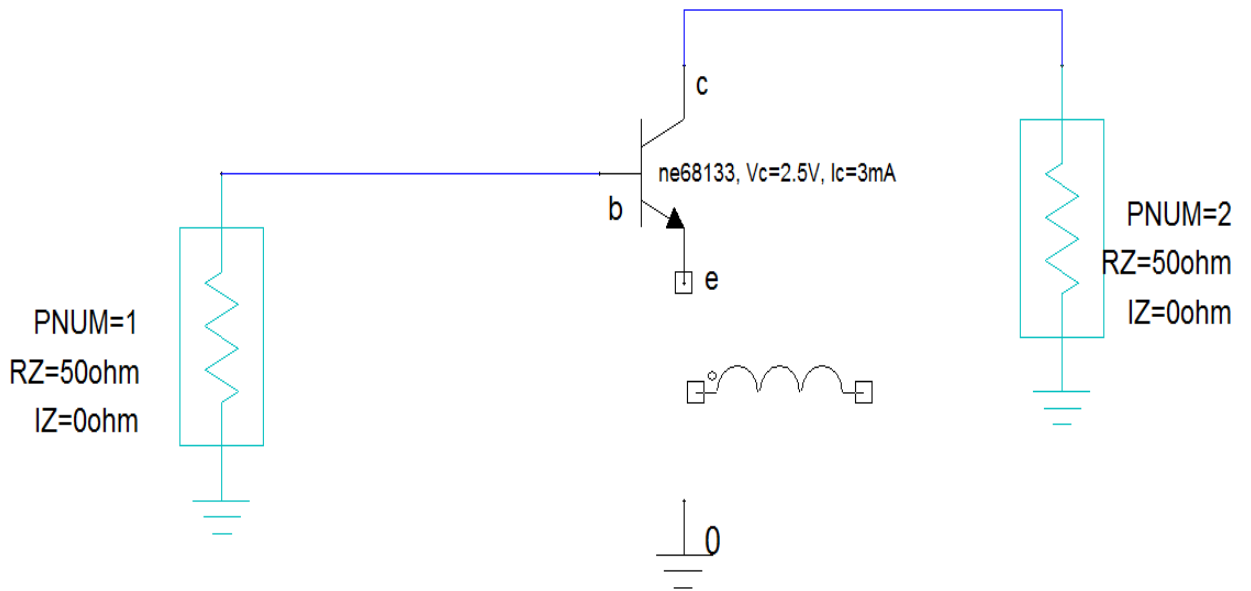

- Right-click the inductor symbol in the schematic and select **Rotate**, and connect the inductor between the emitter and Gnd.

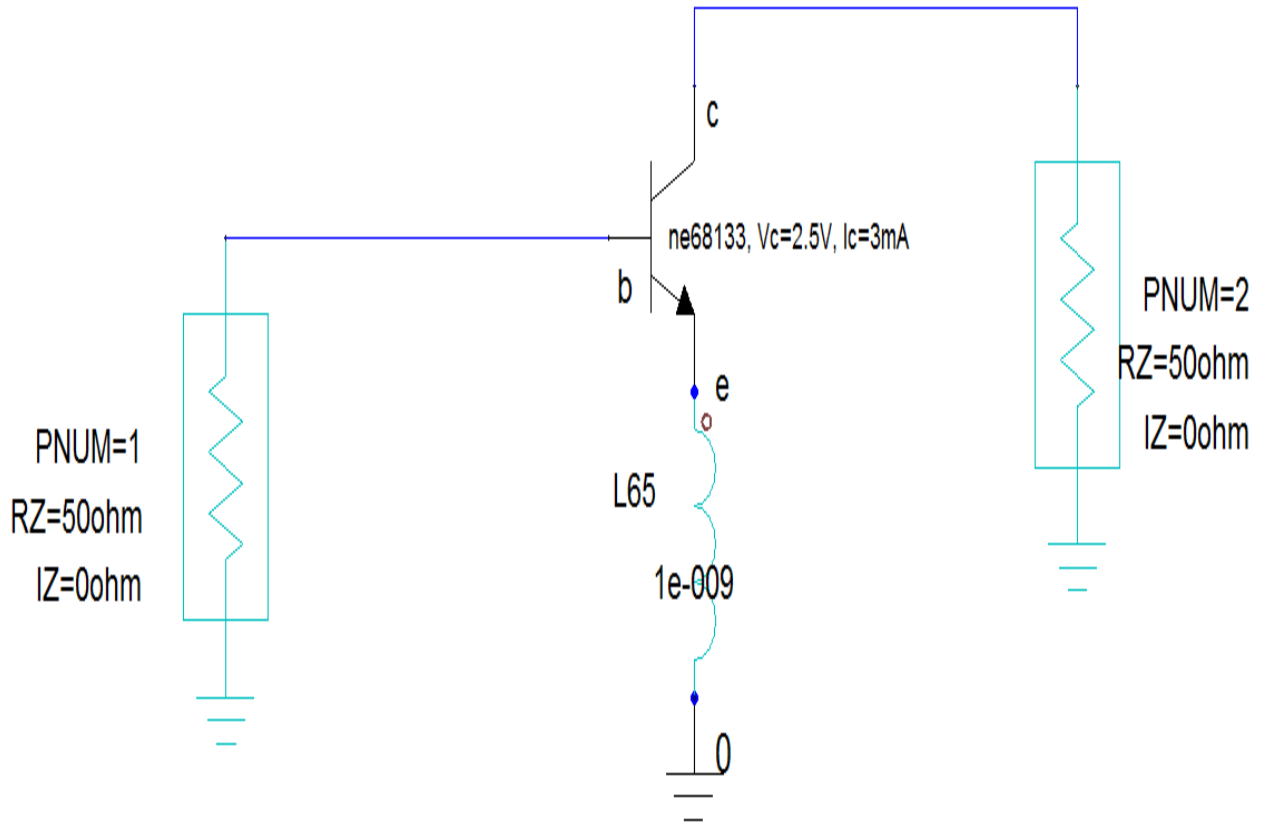

4. Double-click the inductor and set a local variable, L1, with value 0nH and add the appropriate unit, nH, in the unit field.

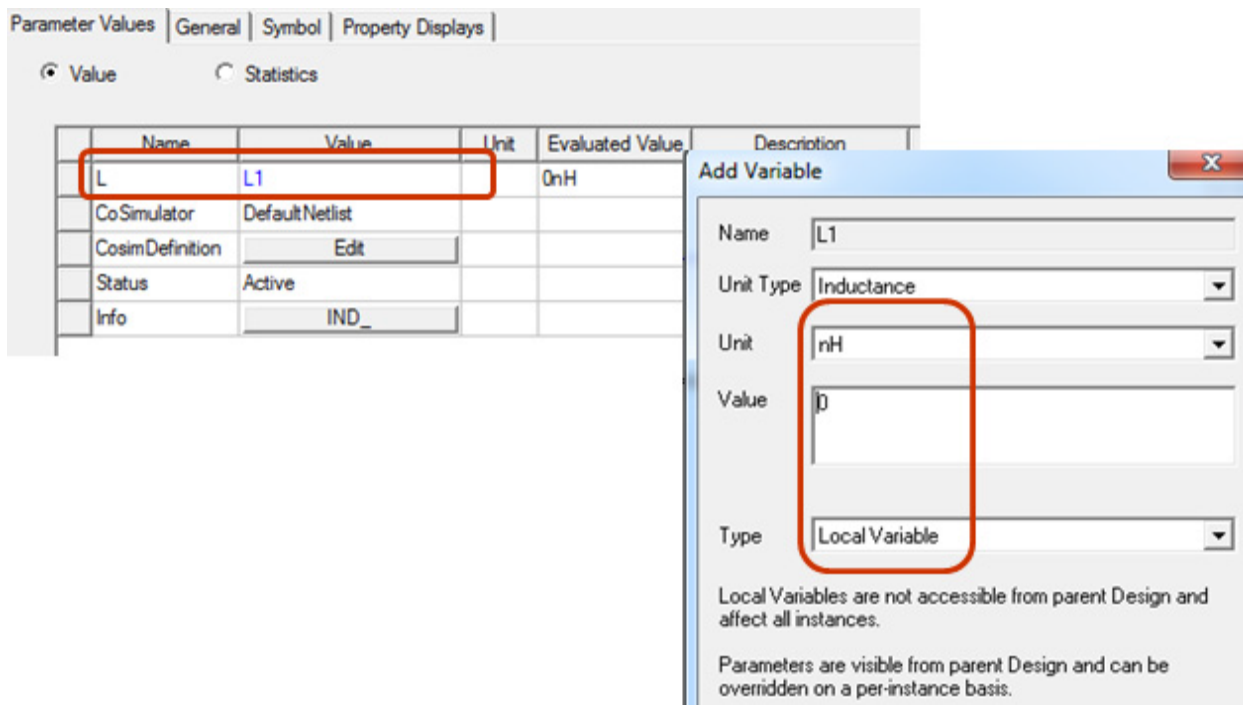

5. Analyze to run the simulation. (See the following Smith Chart.

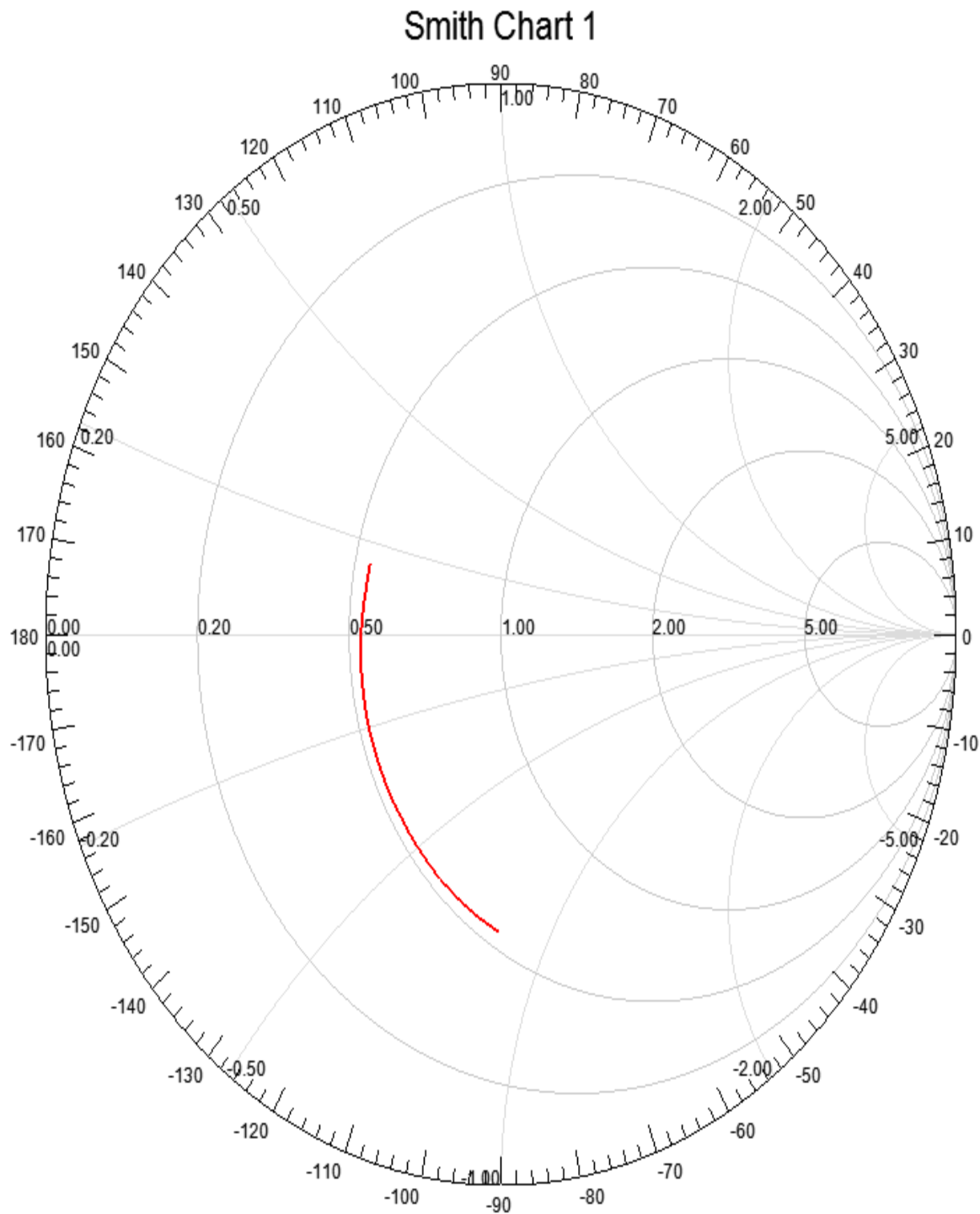

## Set Tuning Parameter

1. From the **Project Manager** window, right-click the project name (**LNA**) and select **Design Properties**.

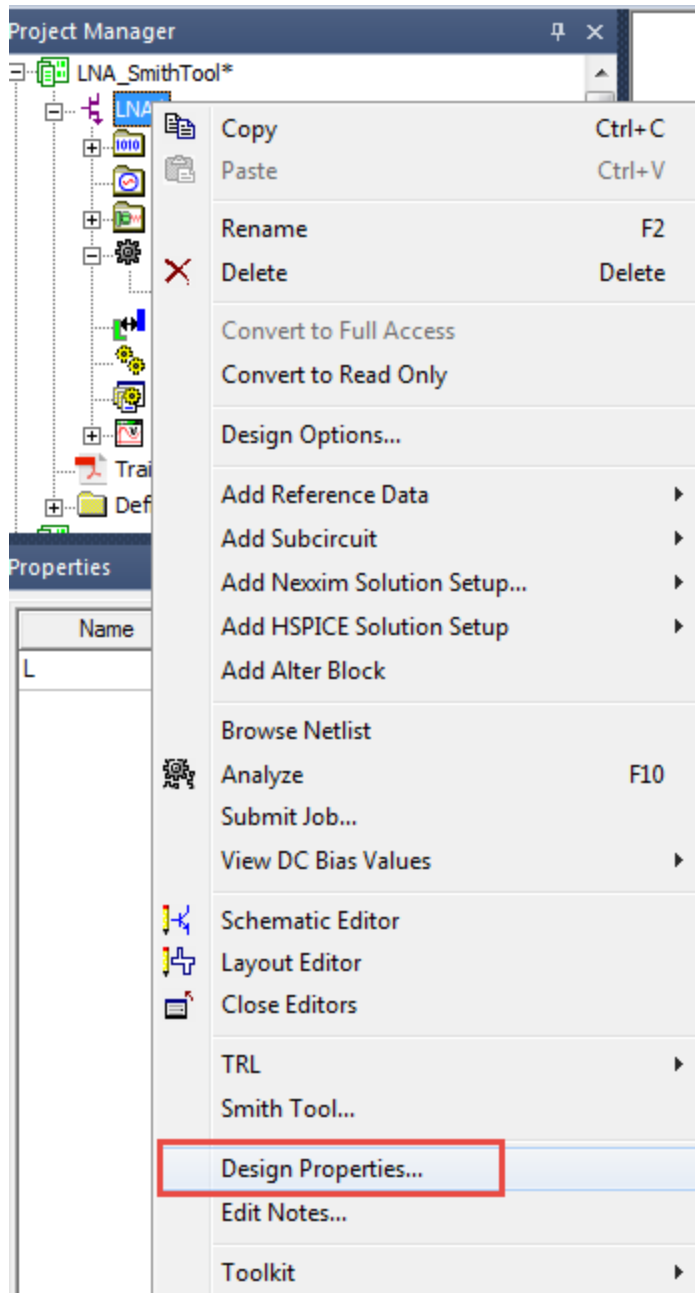

- From the **Local Variables** tab, select the **Tuning** option.

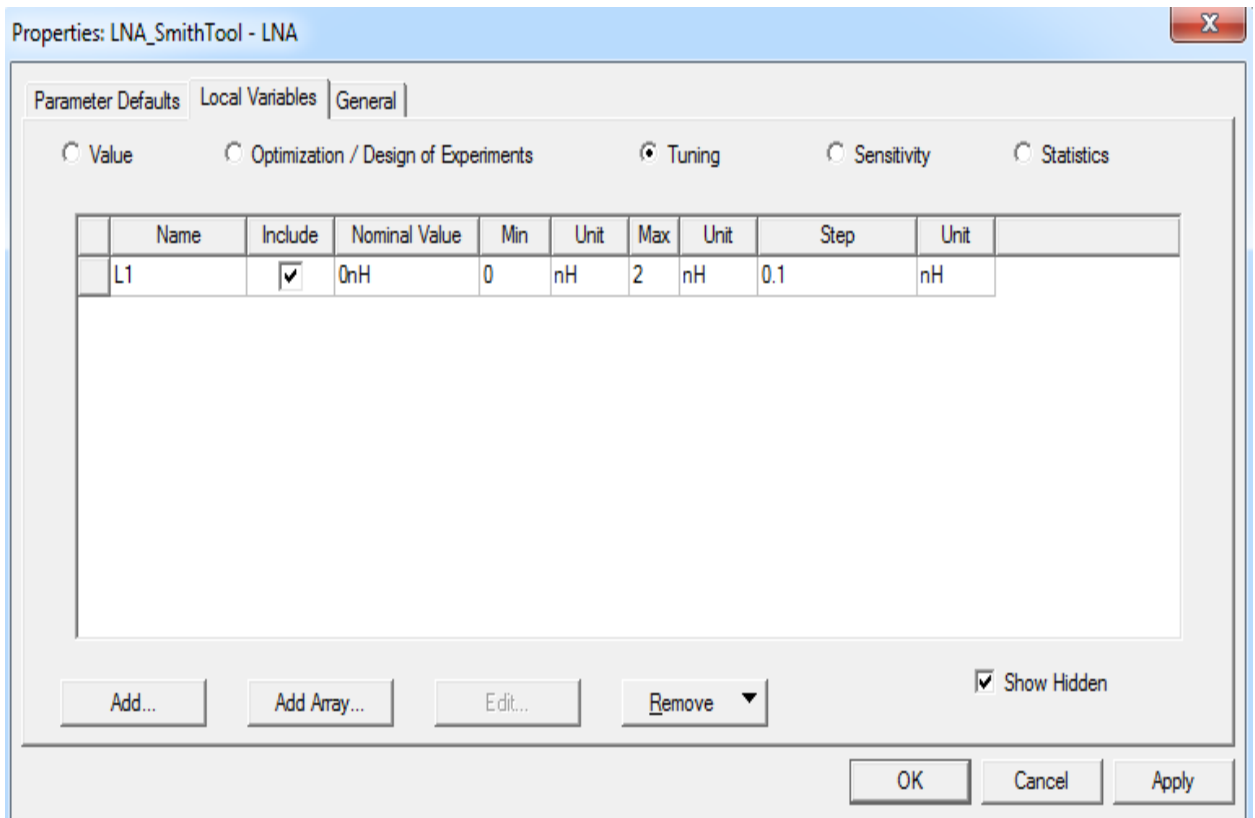

- Select **Include** for L1 and set Min=0, Max=2nH, and Step=0.1nH and click **OK**.
- Run the analysis (F10).

This tuning parameter is used for the inductor as described in the following topic.

## Tune Inductor

Ensure that the Smith chart generated by the Smith Tool utility is open and verify that the stability circles are visible.



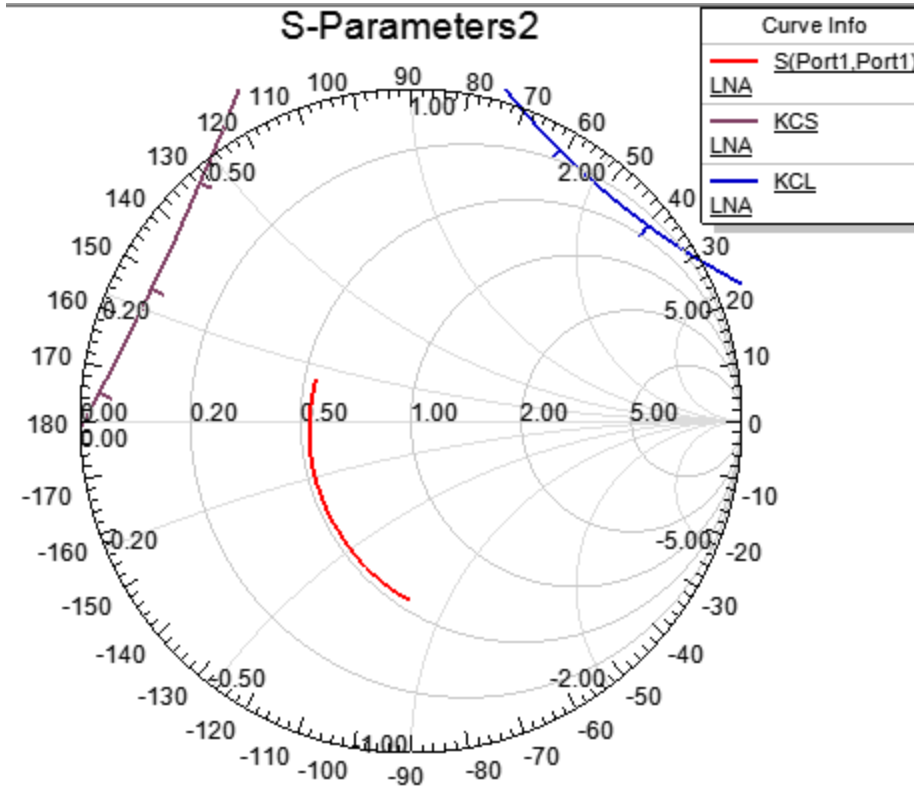

1. From the **Project Manager** window, right-click **Optimetrics** and select **Tuning**.

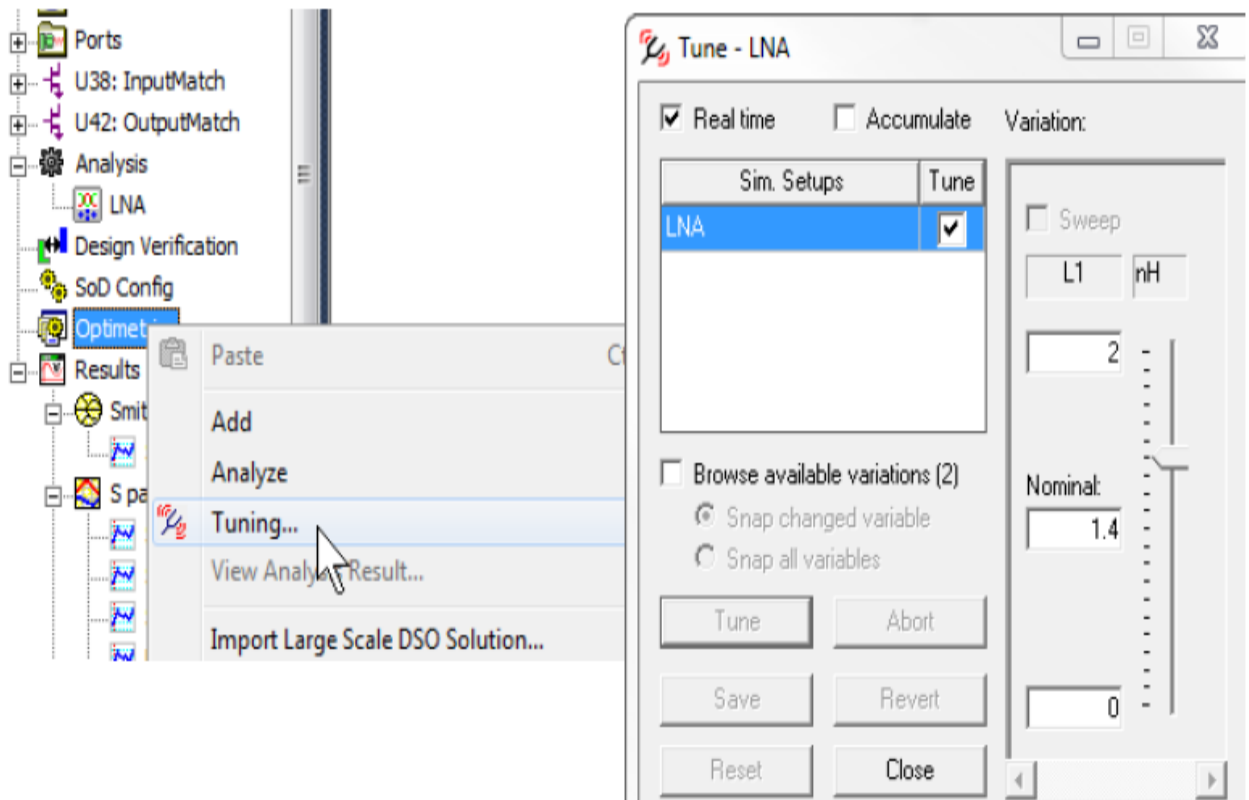

2. Deselect the option **Browse available variations** and tune the inductor value until the stability circles move outside the Smith Chart ( $L \sim 1.4\text{nH}$ ) and click **Close**.

- Click **OK** in the **Apply Tuned Variation** window and analyze the design.

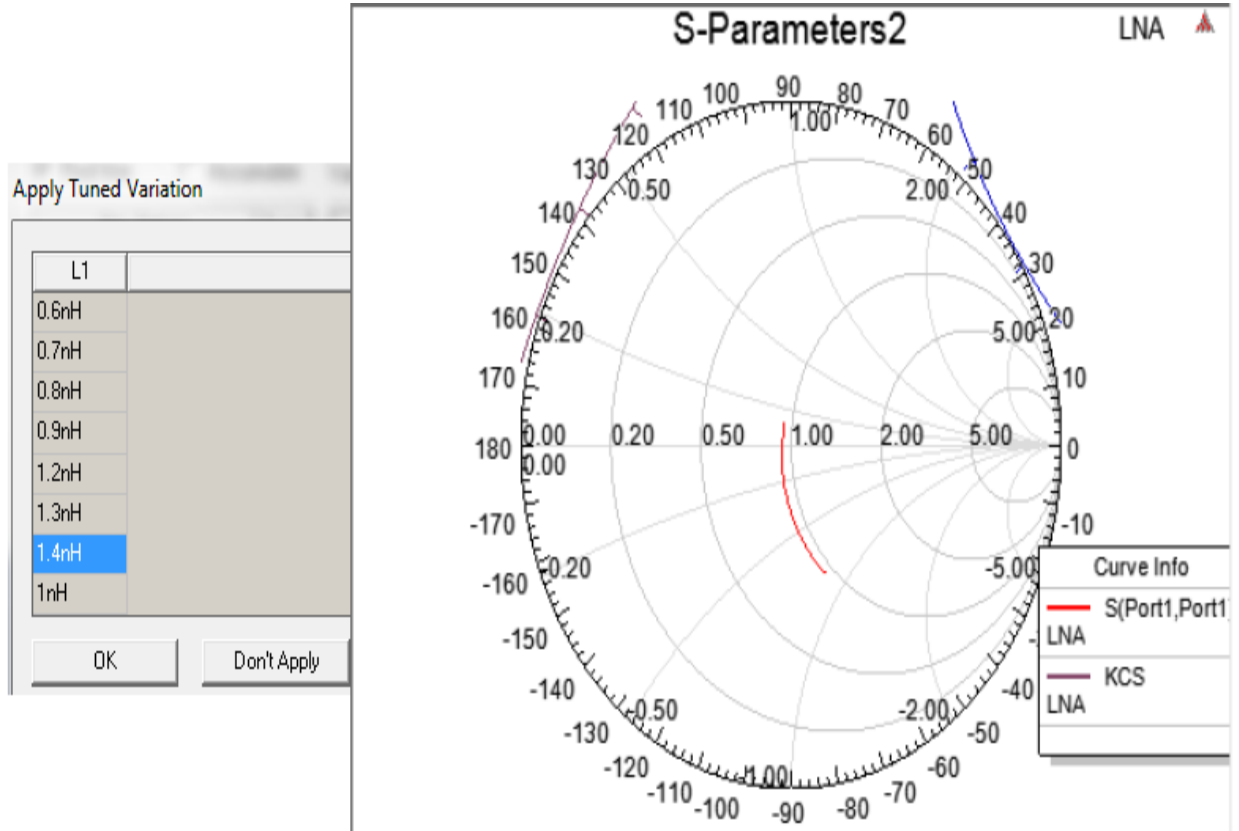

## Matching Circuit

- Select the Smith Chart to make it active.
- From the menu bar, select **Report2D > Smith Tool** to load the Smith Tool utility.
- Set **Freq** to 0.9 GHz.

**Note** At 0.9 GHz,  $K > 1$ ,  $G_{max}$  is 12.69dB,  $F_{min}$  is 1.02 dB.

- Select **Stability K (S-plane)** and click **Apply**.
- Select **Stability K (L-plane)** and click **Apply**.
- Deselect the **Save report on exit** option.

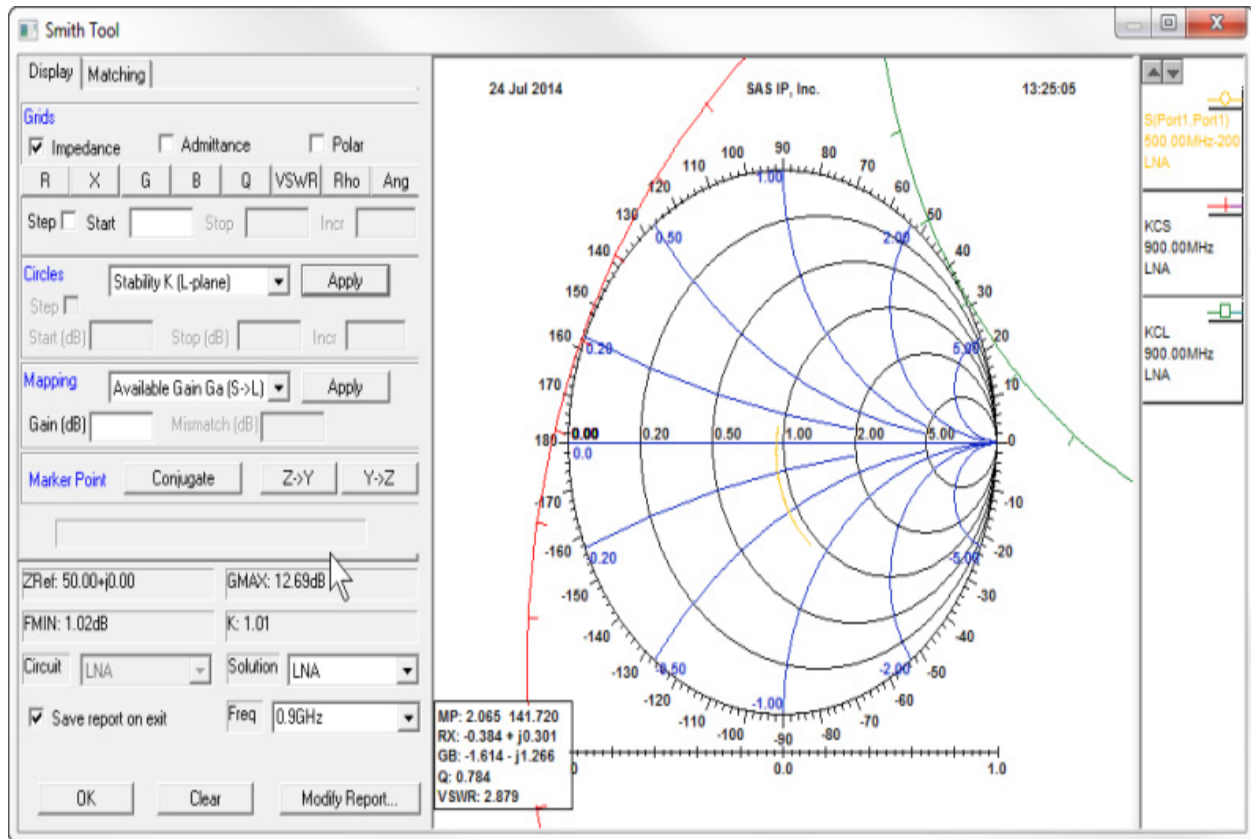

## Add Constant Gain/Noise Circles

1. Select **Available Gain Ga (S-Plane)** on the **Circles** drop-down menu.
2. Enter 12.25 in the **Start** field and click **Apply**.

A 12.25dB gain circle appears.

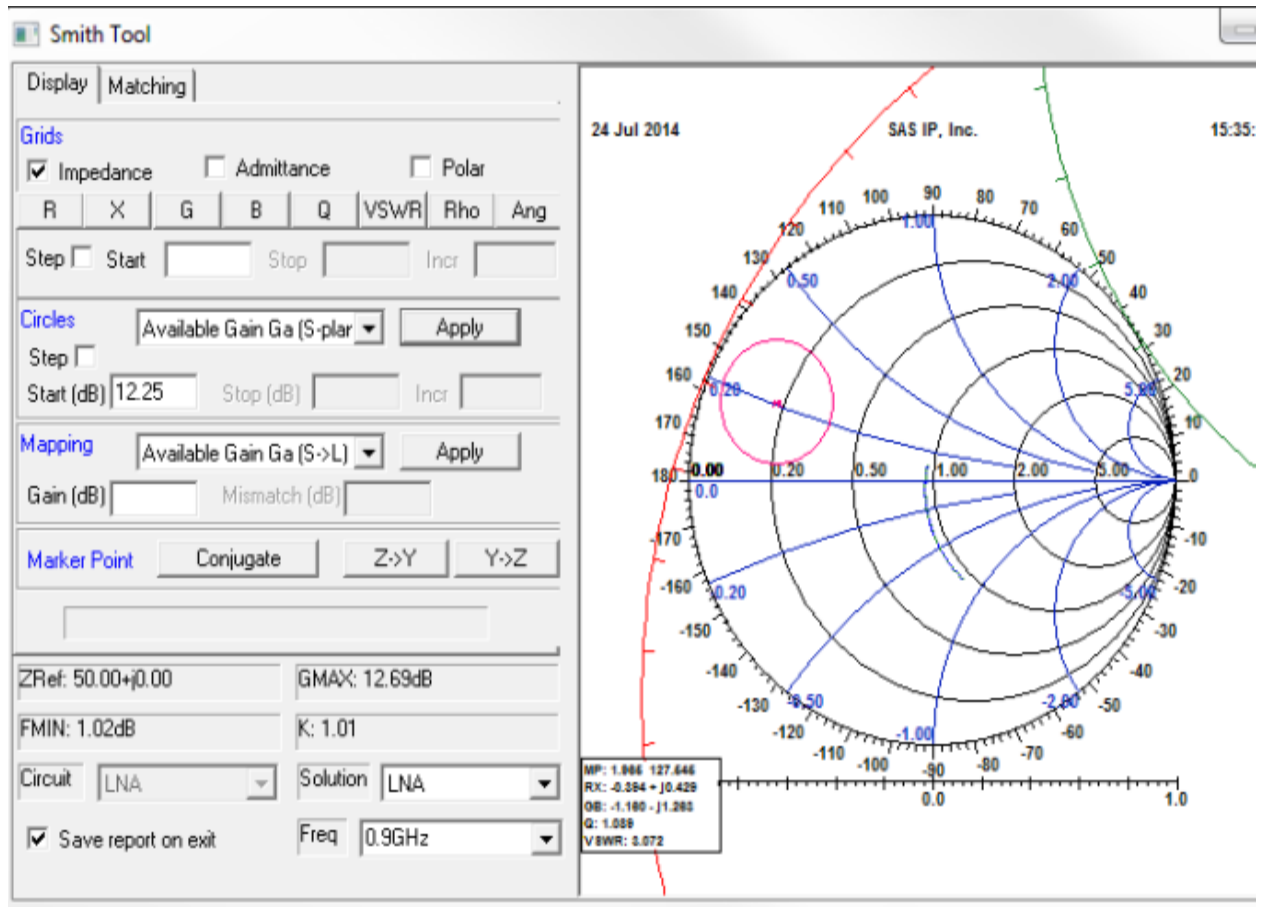

3. Select **Noise** and enter 1.5 dB, and click **Apply**.

A 1.5dB noise circle appears.

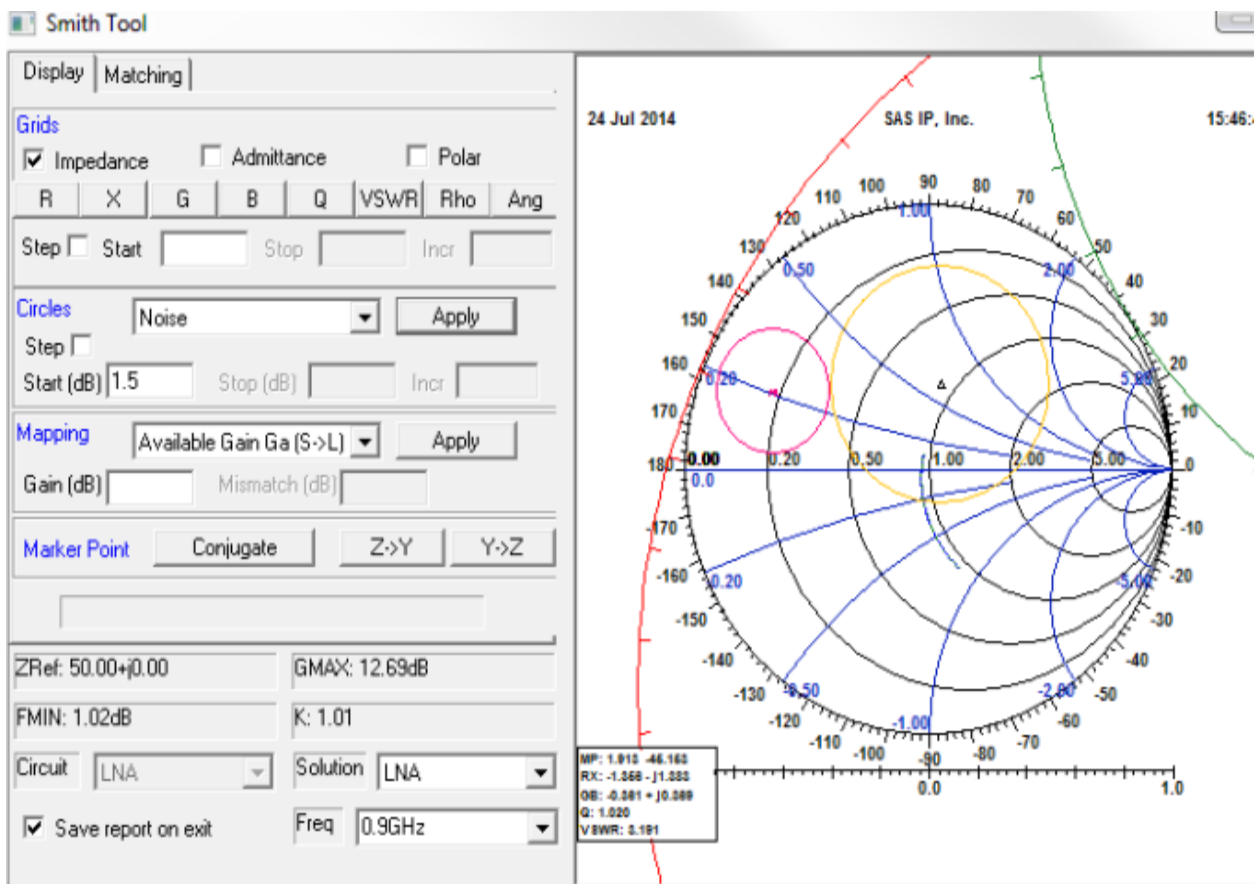

## Smith Tool - Drawing Aids and Matching Tab

1. Enter 1 in the **Start** field of section **Grids** and click **G** to plot the constant circle of real part 1 for the admittance.
2. Click **R** in section **Grids** to plot constant **R** circle.
3. Move the cursor to point P and click **R** to display constant real part circle for the impedance located a point P (where Gain and Noise circles touch).
4. Click **Matching** tab on the **SmithTool** window.

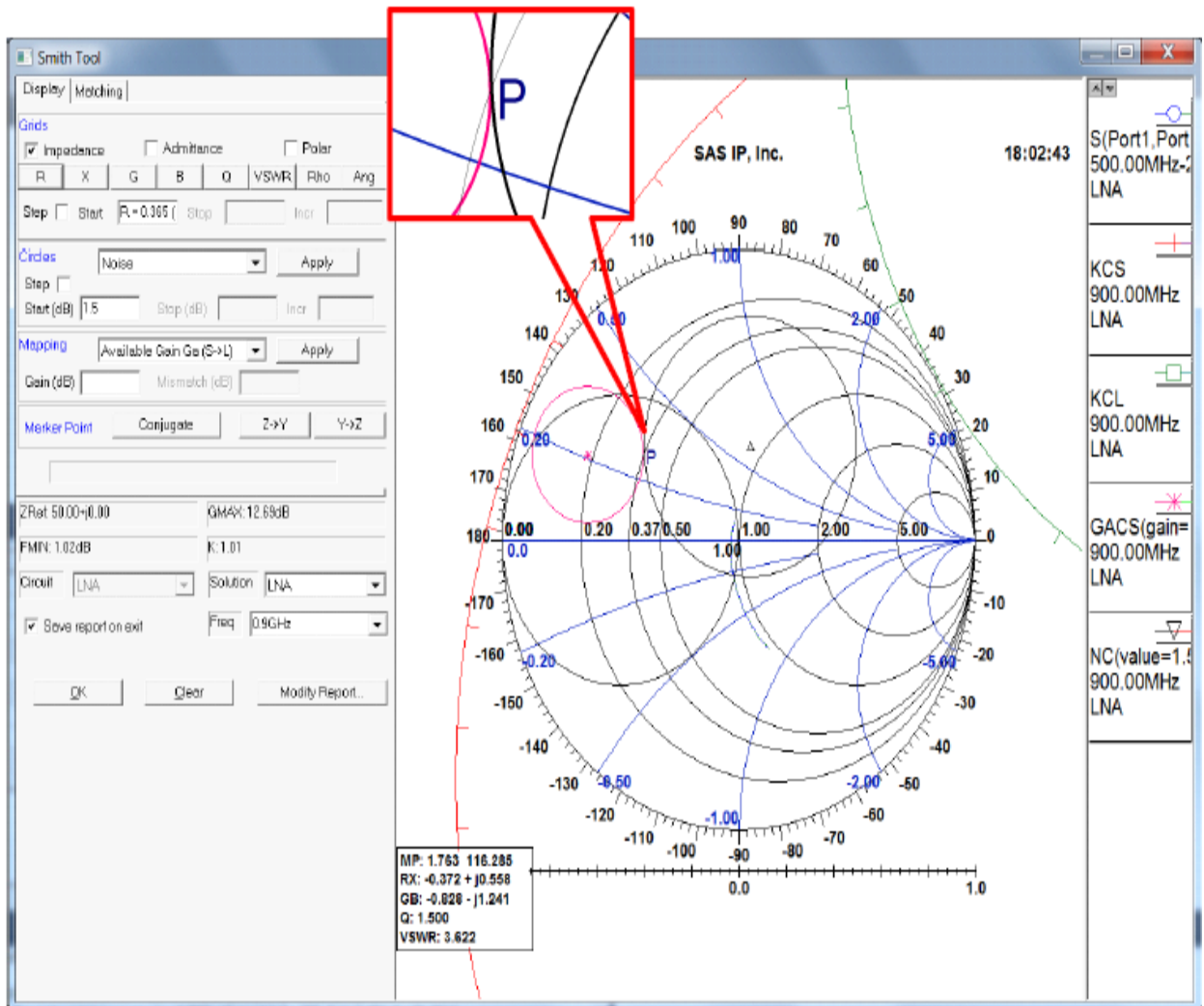

For the input matching circuit, move from 50 Ohms at the center of the chart to the point P.

5. Click **New Match**.

The cursor immediately jumps to the center of the Smith chart.

6. Without moving the mouse, click again to place the “crosshair” at the center (i.e., 50 Ohms).

The ten element buttons in the window become active. These are the elements available for use in the matching circuit, representing both lumped and distributed components.

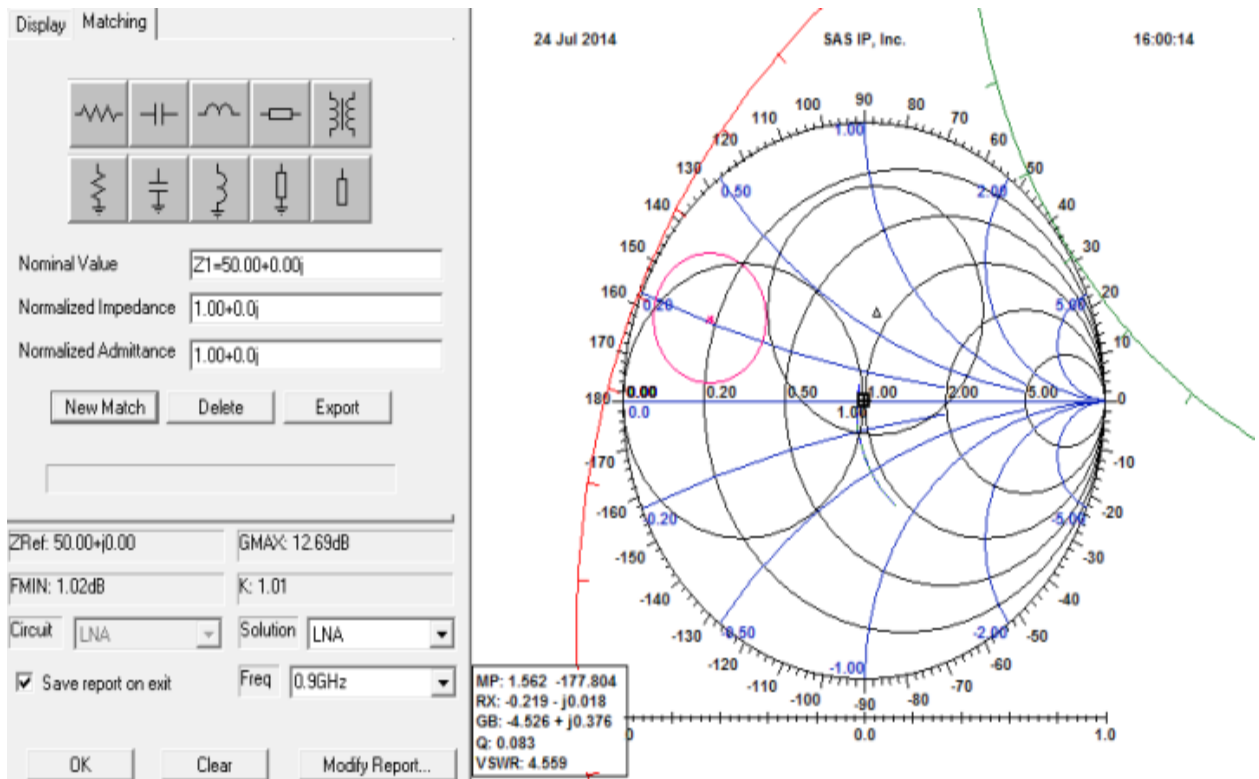

## Input Matching Circuit

1. Click the "shunt L" button .
 

A small "tail" appears on the R = 1 circle.
2. Click the tail and drag it to the constant R circle added earlier (approximately R = 0.36).
3. Click the "series C" button .
 

Again, a tail appears on the last point.
4. Drag this tail to the point P to complete the match.



The approximate values for the matching elements should be:  $L = 6.7\text{nH}$ ,  $C = 19.5\text{pF}$

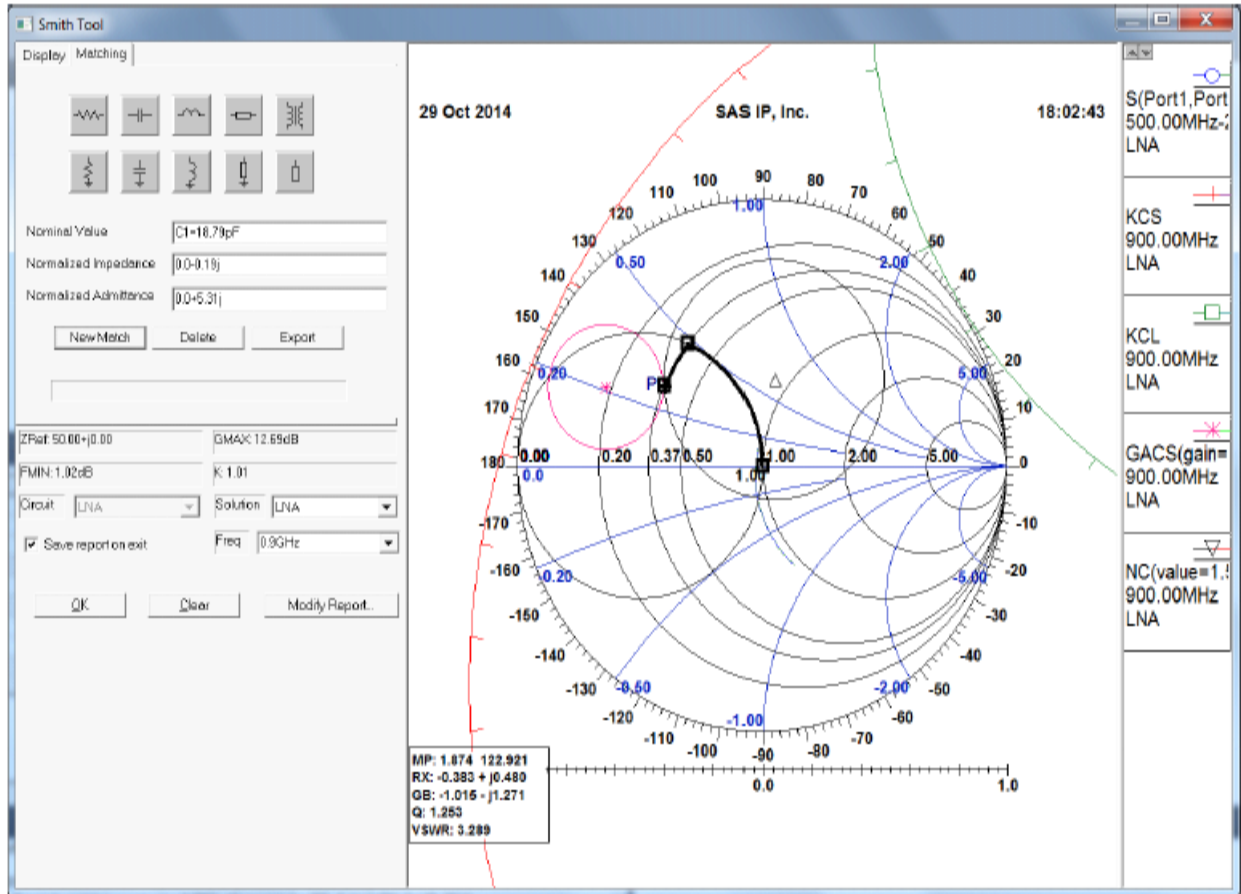

5. Click **Export** to write the subcircuit for the input matching circuit.
6. Click **OK** to confirm that the subcircuit is created.
7. The approximate values for the matching elements should be:  $L = 6.7\text{nH}$ ,  $C = 19.5\text{pF}$

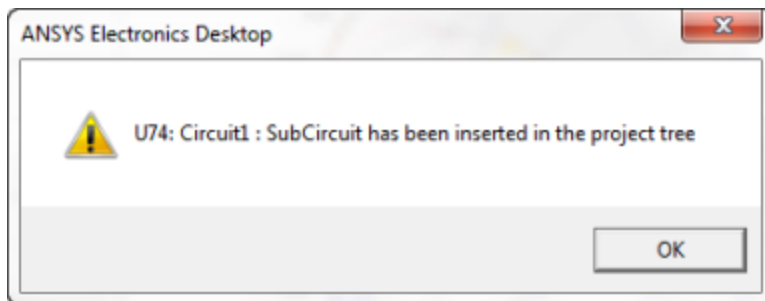

## Smith Tool - Source/Load Mapping

1. Take the point used for our input match and transform it into the load plane.
2. Go to **Display** tab and in the **Mapping** group box, ensure that **Available Gain Ga S->L** is selected.
3. In the **Gain (dB)** box, enter 12.25, which is the same gain value that was used to determine point P, and click **Apply**.
4. After a moment, a message window appears. Click **Yes** to re-analyze.

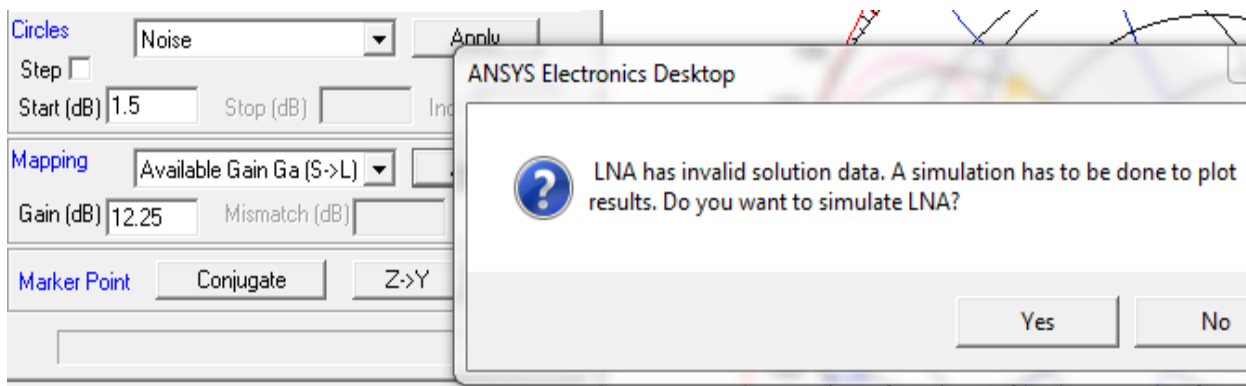

A second circle appears; it represents the source plane gain circle mapped into the load plane.

5. Move the cursor on the source plane to point P.
6. Click point P.

A new point appears on the load plane circle representing the same point, but in the load plane, as shown above. This point is called Q in the following figure.

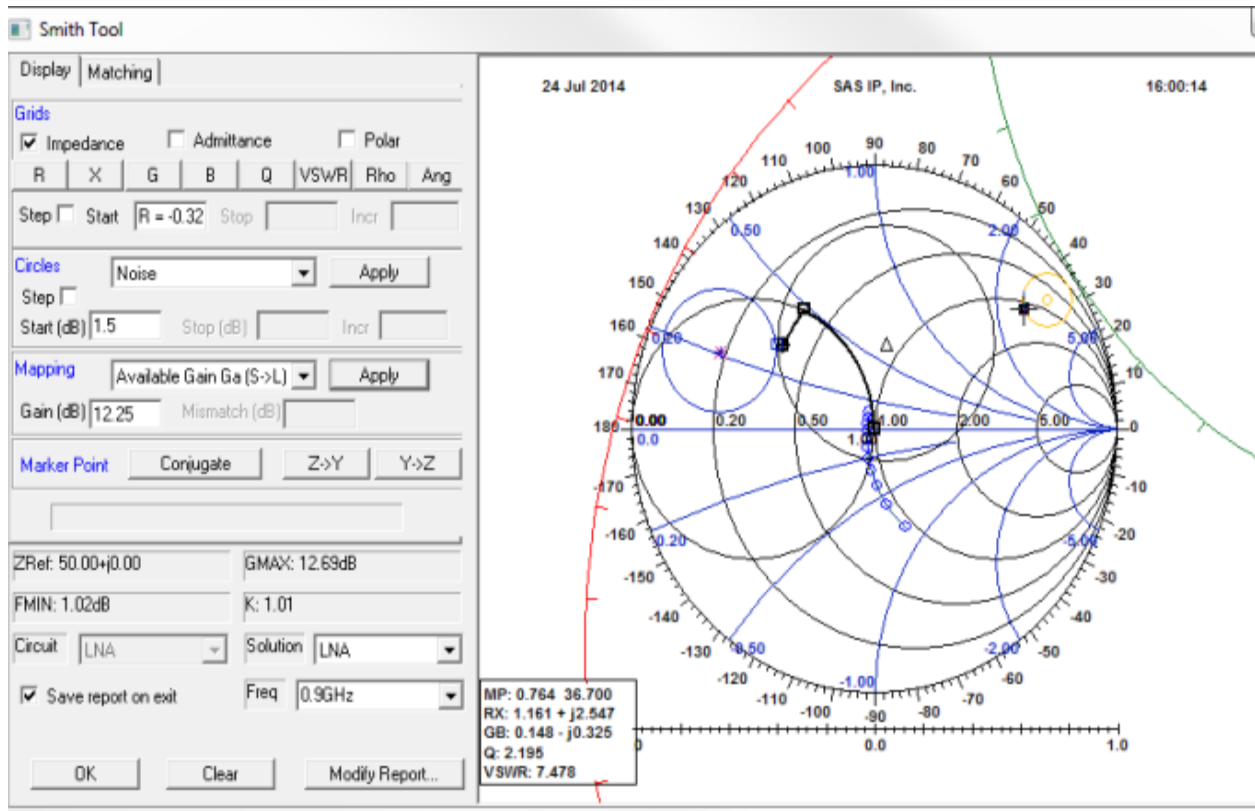

## SmithTool - Complex Conjugation

To complete the output match, take point Q in the load plane and conjugate it. Use the conjugated point,  $Q^*$ , to begin the output match. Click **Conjugate** and click point Q.

This creates a point  $Q^*$  with the equal real part and opposite imaginary part.

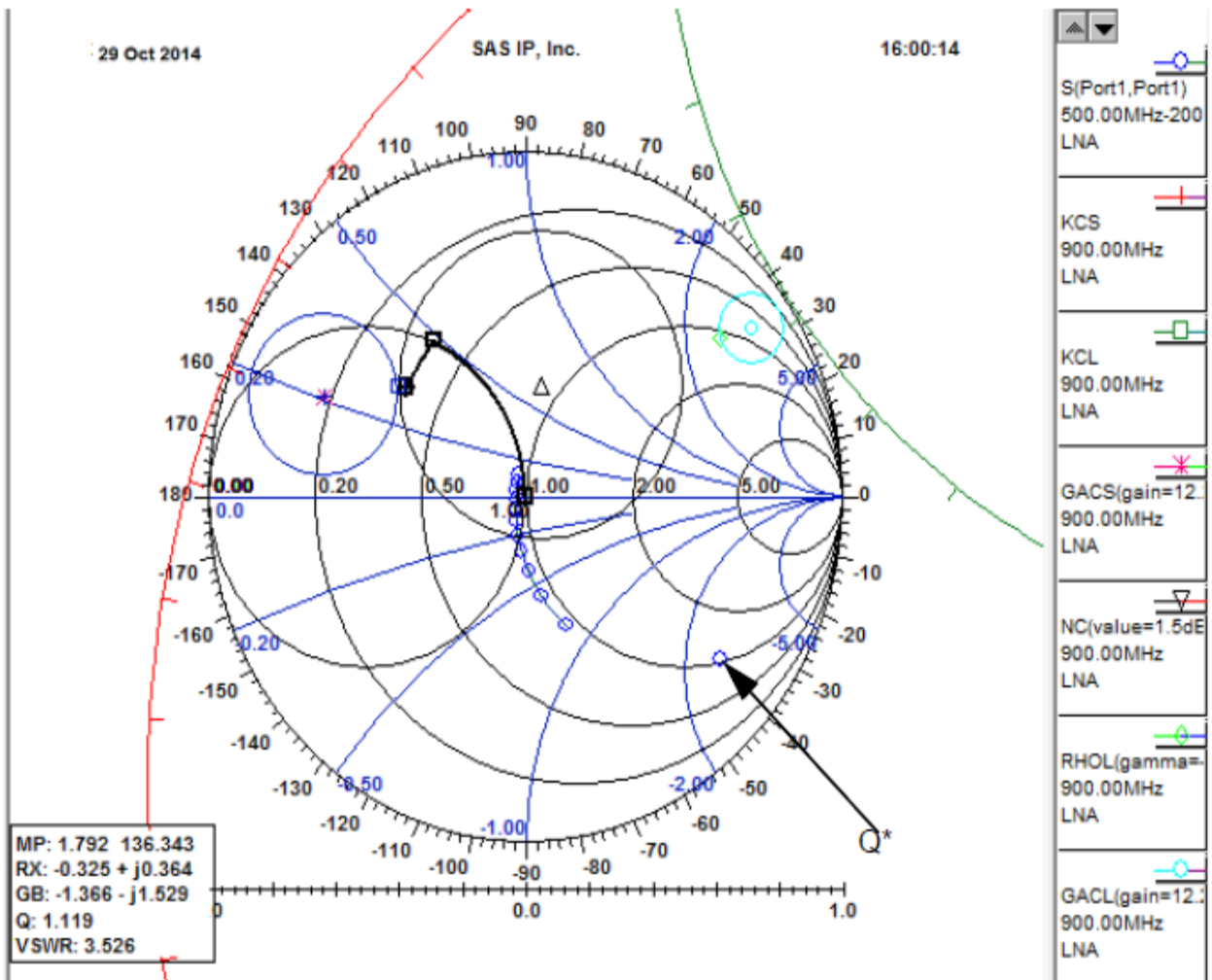



Figure 1-3 Conjugate

## Output Matching Circuit

1. Click **New Match**.

The cursor jumps to the Smith chart.

2. Click the point  $Q^*$  to start the match.

3. Click the "shunt L" button .

4. Drag its tail up to the  $R = 1$  circle.



5. Click the "series C" button
6. Drag its tail down to the center of the chart.

Approximate values are:  $L = 13.1\text{nH}$ ,  $C = 1.45\text{pF}$

7. Click **Export** to write the Subcircuit for the output matching circuit

A window message pops up to confirm that the Subcircuit is created, click **OK**.

8. Click **Clear** and **OK**.
9. A Statistical Eye Plot resembles the following:

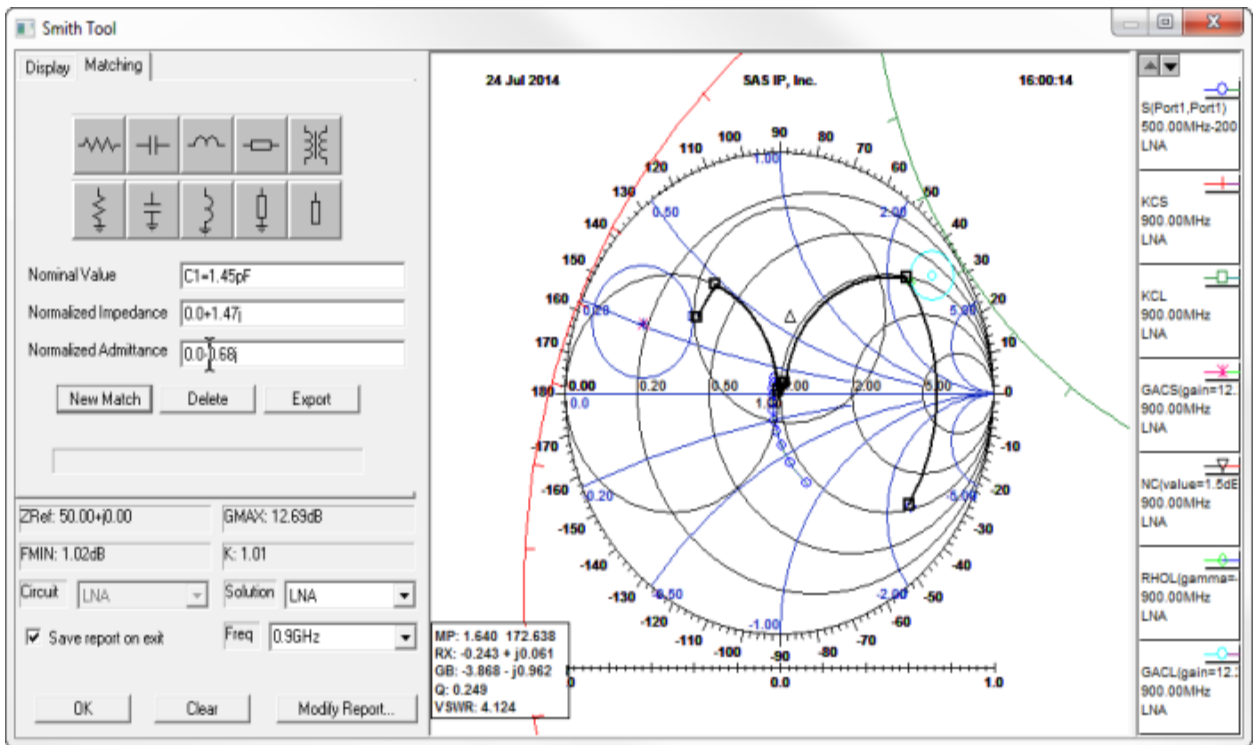

## Building the Amplifier

Sub-Circuit Circuit1 is InputMatch and Sub-Circuit Circuit2 is the OutputMatch. Connect the subcircuits on the schematic as shown to complete the LNA.

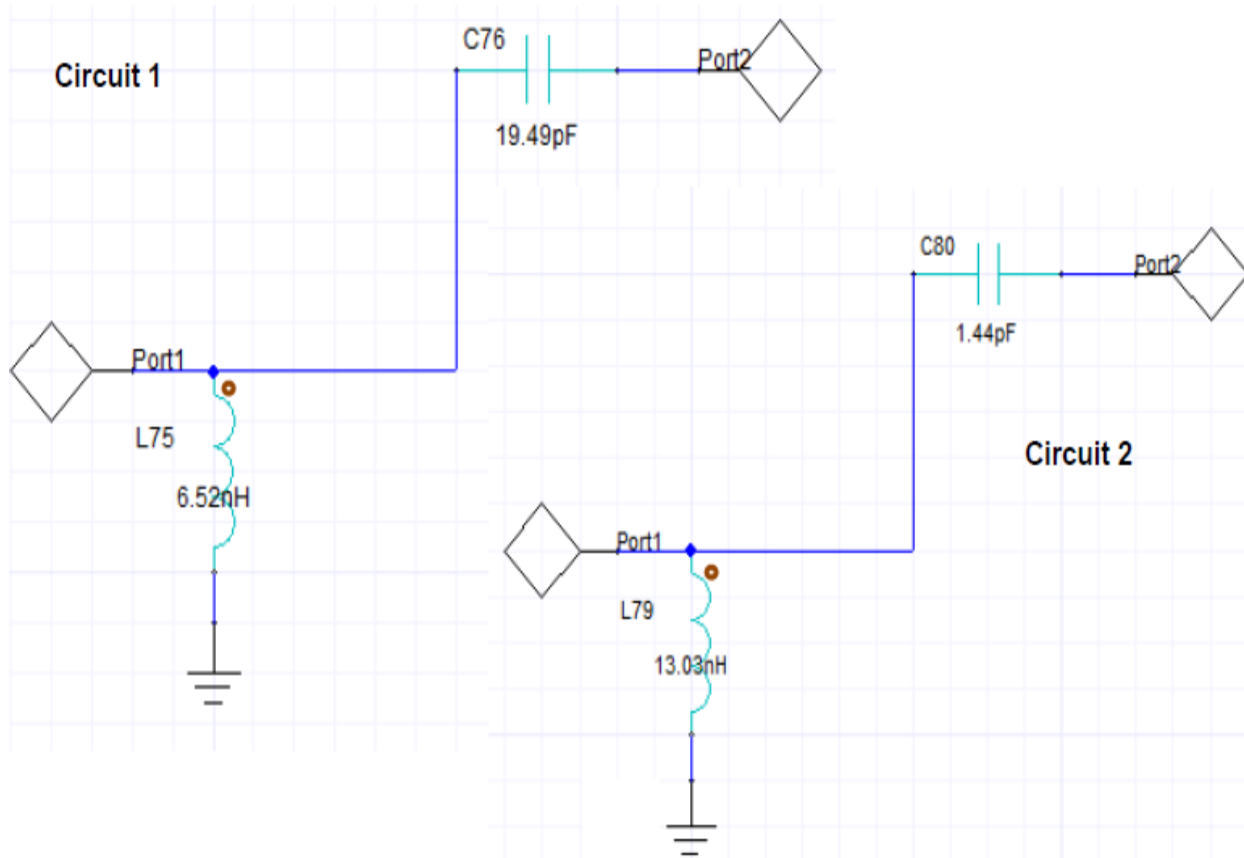

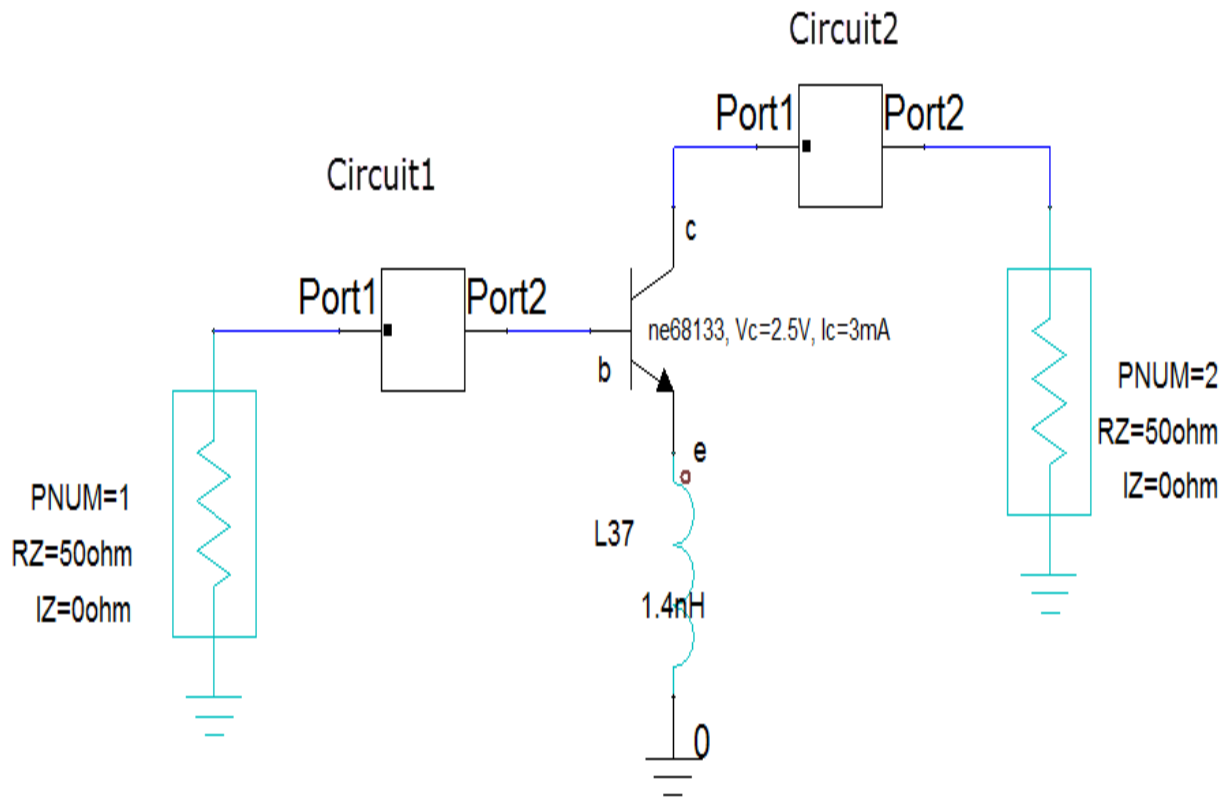

## Verifying Amplifier Performance

1. Run the analysis.
2. Create a new rectangular graph with the following traces:  $dB(S_{11})$ ,  $dB(S_{22})$ ,  $dB(S_{21})$ , and additionally add  $dB(NF)$ .
3. Rename **S Parameter Plot 2** in the **Project Tree** to **LNA Small Signal - 900 MHz**.
4. Right-click the graph and select **Marker > Add X Marker**.
5. Move X Marker to 0.9GHz or modify Marker Properties Xvalue to 0.9GHz.
6. Design goals of 12.25dB gain and 1.5dB NF should have been met.

7. Save the current project as LNAMatch.

